

926-ST1LE

FLOW COMPUTER



Flowmetrics, Inc.

“Where Quality is Measurable”

9201 Independence Avenue • Chatsworth, CA 91311
(818) 407-3420 • FAX (818) 700-1961

Proprietary Notice

The information contained in this publication is derived in part from proprietary and patent data. This information has been prepared for the expressed purpose of assisting operating and maintenance personnel in the efficient use of the instrument described herein. Publication of this information does not convey any rights to use or reproduce it or to use for any purpose other than in connection with the installation, operation and maintenance of the equipment described herein.

Copyright 1995

Printed in USA. All Rights Reserved.



WARNING!

This instrument contains electronic components that are susceptible to damage by static electricity. Proper handling* procedures must be observed during the removal, installation, or handling of internal circuit boards or devices.

*Handling Procedure

1. Power to unit must be removed.
2. Personnel must be grounded, via wrist strap or other safe, suitable means, before any printed circuit board or other internal device is installed, removed or adjusted.
3. Printed circuit boards must be transported in a conductive bag or other conductive container. Boards must not be removed from protective enclosure until the immediate time of installation. Removed boards must be placed immediately in protective container for transport, storage, or return to factory.

Comments

This instrument is not unique in its content of ESD (electrostatic discharge) sensitive components. Most modern electronic designs contain components that utilize metal oxide technology (NMOS, CMOS, etc.). Experience has proven that even small amounts of static electricity can damage or destroy these devices. Damaged components, even though they appear to function properly, may exhibit early failure.



SAFETY INSTRUCTIONS

The following instructions must be observed.

- This instrument was designed and is checked in accordance with regulations in force EN 60950 (“Safety of information technology equipment, including electrical business equipment”). A hazardous situation may occur if this instrument is not used for its intended purpose or is used incorrectly. Please note operating instructions provided in this manual.
- The instrument must be installed, operated and maintained by personnel who have been properly trained. Personnel must read and understand this manual prior to installation and operation of the instrument.
- This instrument is internally fused. Replace the internal fuse with the following specified type and rating only:

Input Power

115 VAC
230 VAC
12-24 VDC

Recommended Fuse

160 mA slow blow fuse
80 mA slow blow fuse
800 mA slow blow fuse

Disconnect power supply before replacing fuse!

- The manufacturer assumes no liability for damage caused by incorrect use of the instrument or for modifications or changes made to the instrument.

Symbols Used On Unit

<u>Number</u>	<u>Symbol</u>	<u>Publication</u>	<u>Description</u>
1	==	IEC 417, No. 5031	Direct current
2		IEC 417, No. 5172	Equipment protected throughout by DOUBLE INSULATION or REINFORCED INSULATION (equivalent to Class II of IEC 536—see annex H)
3		ISO 3864, No. B.3.1	Caution (refer to accompanying documents)

Technical Improvements

- The manufacturer reserves the right to modify technical data without prior notice.

CONTENTS

1. DESCRIPTION

1.1 Unit Description	1
1.2 Unit Features	1
1.3 Specifications	2

2. INSTALLATION

2.1 General Mounting Hints	6
2.2 Mounting Diagrams	6

3. APPLICATIONS

3.1 Liquid Volume	7
3.2 Batching	8

4. WIRING

4.1 Typical Batcher Wiring	9
4.2 Typical Rate/Total Wiring	9

5. UNIT OPERATION

5.1 Front Panel Operation Concept for Run Mode	10
5.2 General Operation	11
5.3 Ratemeter/Totalizer Operation	11
5.3.1 Password Protection for Rate/Total mode	11
5.3.2 Relay Operation in Rate/Total mode	11
5.3.3 Pulse Output in Rate/Total mode	11
5.3.4 Analog Output in Rate/Total mode	11
5.3.5 RS-232 Serial Port Operation in Rate/Total mode	12
5.3.6 RS-485 Serial Port Operation in Rate/Total mode	12
5.4 Batcher Operation	13
5.4.1 Batcher Configuration	13
5.4.2 Password Protection for Batcher mode	14
5.4.3 Relay Operation in Batcher mode	14
5.4.4 Pulse Output in Batcher mode	14
5.4.5 Analog Output in Batcher mode	14
5.4.6 RS-232 Serial Port Operation in Batcher mode	15
5.4.7 RS-485 Serial Port Operation in Batcher mode	15

6. PROGRAMMING

6.1 Front Panel Operation Concept for Program Mode	16
6.2 EZ Setup	17
6.3 Setup Menus	18
6.4 Setup Sub-Menus	19
6.4.1 SELECT EZ SETUP	19
6.4.2 INSTRUMENT TYPE	19
6.4.3 SETUP INDICATORS (Total)	21
6.4.4 SETUP INDICATORS (Rate)	21
6.4.5 SETUP FLOW INPUT (Pulse - chA & chA=chB)	22
6.4.6 SETUP FLOW INPUT (Pulse - Quadrature, Qx1 or Qx2)	23
6.4.7 SETUP PULSE OUTPUT	24
6.4.8 SETUP ANALOG OUTPUT	25
6.4.9 SETUP RELAYS	25
6.4.10 SETUP CONTROL INPUTS (RATE/TOTAL)	27
6.4.11 SETUP CONTROL INPUTS (BATCH)	27
6.4.12 SETUP REALTIME CLOCK (Time)	28
6.4.13 SETUP REALTIME CLOCK (Date)	28
6.4.14 SERIAL USAGE	29
6.4.15 SET DATALOG/PRINT (Configure)	30
6.4.16 SET DATALOG/PRINT (Select_list)	31
6.4.17 ADMINISTRATIVE SETUP	31
6.4.18 SETUP NETWORK CARD	32

CONTENTS

7. PRINCIPLE OF OPERATION

7.1 General	33
7.2 Flow Equations	33
7.3 Linearization Table	34
7.6.1 Linearization Table General Information	34
7.6.2 Linearization Table for Pulse Inputs	34
7.6.3 Linearization Table Interpolation	34

8. TEST, SERVICE and MAINTENANCE

8.1 Test Menus	35
8.2 Test Sub-Menus	36
8.2.1 Audit Trail	36
8.2.2 Error History	36
8.2.3 Print System Setup	36
8.2.4 Keypad test	37
8.2.5 Display test	37
8.2.6 Calibrate 0mA out	37
8.2.7 Calibrate 20mA out	37
8.2.8 Pulse input test	38
8.2.9 Analog out test	38
8.2.10 Excitation out test	39
8.2.11 Pulse out test	39
8.2.12 Relay test	39
8.2.13 Control input test	39
8.2.14 Data logger utility	39
8.3 Internal Fuse Replacement	40

9. RS-232 SERIAL PORT

9.1 RS-232 Serial Port Description	41
9.2 Instrument Setup by PC Over Serial Port	41
9.3 Operation of Serial Communication Port with Printers	41
9.4 926-ST1LE RS-232 Port Pinout	41

10. RS-485 SERIAL PORT

10.1 RS-485 Serial Port Description	42
10.2 General	42
10.3 Operation of Serial Communication Port with PC	42
10.4 926-ST1LE RS-485 Port Pinout	42

11. FLOW COMPUTER SETUP SOFTWARE

11.1 System Requirements	43
11.2 Cable and Wiring Requirements	43
11.3 Installation for Windows™3.1 or 3.11	43
11.4 Using the Flow Computer Setup Software	43
11.5 File Tab	44
11.6 Setup Tab	44
11.7 View Tab	45
11.8 Misc. Tab	45

12. GLOSSARY OF TERMS

12 Glossary Of Terms	46
----------------------------	----

13. DIAGNOSIS AND TROUBLESHOOTING

13.1 Response of 926-ST1LE on Error or Alarm:	50
13.2 Diagnosis Flow Chart and Troubleshooting	51
13.3 Error & Warning Messages:	52
13.3.1 Sensor/Process Alarms	52
13.3.2 Self Test Alarms	52

Order Code and Warranty	53
-------------------------------	----

APPENDIX A

Setup Menu Flowchart	54
----------------------------	----

1. Description

1.1 Unit Description:

The 926-ST1LE Flow Computer satisfies the rate, total and batching instrument requirements for a variety of pulse producing flowmeter types in liquid applications. Multiple flow equations and instrument functions are available in a single unit with many advanced features.

The alphanumeric display shows measured and calculated parameters in easy to understand format. Single key direct access to measurements and display scrolling is supported.

The versatility of the 926-ST1LE permits a wide measure of versatility within the instrument package. The various hardware inputs and outputs can be “soft” assigned to meet a variety of common application needs. The user “soft selects” the usage of each input/output while configuring the instrument. Consider the following illustrative examples.

The user can assign the standard RS-232 Serial Port for data logging, transaction printing, or for connection to a modem for remote meter reading.

1.2 Unit Features:

The 926-ST1LE Flow Computer offers the following features:

- Compatible with Pulse Producing Flowmeters
- Multiple Instrument Functions; Rate, Total, Batching
- Menu Selectable Hardware & Software Features
- Two Line LCD Display
- Automatic Batch Overrun Compensation
- Isolated Pulse Output Standard
- Isolated Analog Output Standard
- Versatile RS-232 Port Standard
- Linearization Capability Standard
- DIN Enclosure with Two Piece Connectors
- EZ Setup Feature
- Advanced Batching Features

1.3 Specifications:

Specifications:

Environmental

Indoor Use
 Altitude up to 2000m
 Operating Temperature: 0°C to +50°C
 (-20°C to 55°C optional)
 Storage Temperature: -40°C to +85 C
 Maximum Relative Humidity : 80% for temperatures
 up to 31°C decreasing linearly to 50% RH at
 40°C
 Main supply voltage fluctuations not to exceed
 ±10% of the nominal voltage
 Transient overvoltage according to INSTALLATION
 CATEGORY II (see UL 3101-1 Annex J)
 POLLUTION DEGREE 2 in accordance with
 IEC 664 (see 3.7.3)
 Materials: UL, CSA, VDE approved

Approvals: CE Compliant Light Industrial,
 UL File #: E192404, C/UL

Display

Type: 2 lines of 20 characters
 Types: Backlit LCD
 Character Size: 0.3" nominal
 User selectable label descriptors and units of
 measure

Keypad

Keypad Type: Membrane Keypad
 Keypad Rating: Sealed to Nema 4
 Number of keys: 16

Enclosure

Size: See Dimensions
 Depth behind panel: 6.5" including mating
 connector
 Type: DIN
 Materials: Plastic, UL94V-0, Flame retardant
 Bezel: Textured per matt finish
 Equipment Labels: Model, safety, and user wiring

Power Input

The factory equipped power option is internally fused.
 An internal line to line filter capacitor is provided for
 added transient suppression.
 Order Option 1: 110VAC: 85 to 127 Vrms, 50/60 Hz
 Order Option 2: 220VAC: 170 to 276 Vrms, 50/60
 Hz
 Order Option 3: 12VDC: 10.5 to 14 VDC
 Order Option 4: 24VDC: 18 to 24 VDC

Flow Inputs:

Pulse Inputs:

Number of Flow Inputs: one
 Configurations supported: single input with or
 without quadrature (menu selectable)
 Input Impedance: 10 K Ω nominal
 Pullup Resistance: 10 K Ω to 5 VDC (menu
 selectable)
 Pull Down Resistance: 10 K Ω to common
 Trigger Level: (menu selectable)
 High Level Input
 Logic On: 3 to 30 VDC
 Logic Off: 0 to 1 VDC
 Low Level Input (mag pickup)
 Selectable sensitivity: 10 mV & 100 mV
 Minimum Count Speed: User selectable down to
 1 pulse in 99 sec.
 Maximum Count Speed: Selectable: 0 to 20kHz
 Overvoltage Protection: 50 VDC
 Fast Transient: Protected to 500 VDC
 (Capacitive Clamp)

Control Inputs

Switch Inputs are menu selectable for Start, Stop,
 Reset, Lock, Inhibit, Alarm Acknowledge, Print or
 Not Used.

Control Input Specifications

Input Scan Rate: 10 scans per second
 Logic 1: 4 - 30 VDC
 Logic 0: 0 - 0.8 VDC

Transient Suppression: 500 V fast transient
 (Capacitive Clamp)

Input Impedance: 100 K Ω
 Control Activation: Positive Edge or Pos. Level
 based on product definition

Excitation Voltage

110/220 VAC Powered Units
 Menu Selectable: 5, 12 or 24 VDC @ 100mA
 24 VDC Powered Units
 Menu Selectable: 5 or 12 VDC @ 100mA
 12 VDC Powered Units
 5 VDC @ 100mA

Relay Outputs

The relay outputs are menu assignable to (Individually for each relay) Low Rate Alarm, Hi Rate Alarm, Prewarn Alarm, Preset Alarm, General purpose warning (security), overrun or not used.

Number of relays: 2 (4 optional)

Contact Style: Form C contacts

Contact Ratings: 250 VAC @ 5 amps
30 VDC @ 5 amps

Fast Transient Threshold: 1000 V

Serial Communication

The serial port can be used for printing, datalogging, modem connection and communication with a computer.

RS-232:

Device ID: 01-99

Baud Rates: 300, 600, 1200, 2400, 4800, 9600,
19200

Parity: None, Odd, Even

Handshaking: None, Software, Hardware

Print Setup: Configurable print list and
formatting

RS-485:

Device ID: 01-247

Baud Rates: 2400, 4800, 9600, 19200

Parity: None, Odd, Even

Protocol: Modbus RTU (Half Duplex)

Analog Output

The analog output is menu assignable to correspond to the Rate or Total.

Type: Isolated Current Sourcing

Isolated I/P/C: 500 V

Available Ranges: 4-20 mA, 0-20 mA

Resolution: 12 bit

Accuracy: 0.05% FS at 20 Degrees C

Update Rate: 1 update/sec minimum

Temperature Drift: Less than 200 ppm/C

Maximum Load: 1000 ohms (at nominal line voltage)

Compliance Effect: Less than .05% Span

60 Hz rejection: 40 dB minimum

Calibration: Operator assisted Learn Mode

Averaging: User entry of DSP Averaging constant to cause a smooth control action.

Isolated Pulse output

The isolated pulse is assigned to Volume Total.

Isolation I/O/P: 500 V

Pulse Output Form: Isolated Photomos Relay

Maximum On Current: 125 mA

Maximum Off Voltage: 30 VDC

Saturation Voltage: 1.0 VDC

Maximum Off Current: 0.1 mA

Pulse Duration: User selectable: 10mSec, 100mSec

Pulse output buffer: 8 bit

Fault Protection

Reverse polarity: Shunt Diode

Transient Protection: 500 VDC

(Capacitive Clamp)

Operating Mode

The Flow Computer can be thought of as making a measurement of flow and then performing calculations which are then updated periodically on the display as rate and total. The pulse output, analog output and the alarm relays are also updated. The cycle then repeats itself.

Step 1: Update the measurements of input signals-
Raw Input Measurements are made at each input.

Step 2 : Compute the Volumetric Flow-
Uncompensated flow is the term given to the flow in volume units. The value is computed based on the flowmeter input type selected and augmented by any performance enhancing linearization that has been specified by the user.

Step 3: Check Flow Alarms-
The flow alarm functions have been assigned to flow rate during the setup of the instrument. A comparison is now made by comparing the current flow rates against the specified hi and low limits.

Step 4: Compute the Flow Totals by Summation-
A flow total increment is computed for each flow rate. This increment is computed by dividing the pulses by the K-Factor and then summing. The totalizer format also includes provisions for total rollover.

Step 5: Total Preset Comparisons-
The total associated with a preset function is then compared against the corresponding preset value and any required control actions taken.

Step 6: Pulse Output Service-
The pulse output is next updated by scaling the total increment which has just been determined by the pulse output scaler and summing it to any residual pulse output amount.

Step 7: Compute the Analog Output-
This designated flow rate value is now used to compute the analog output.

Step 8: Update Display and Printer Output-
The instrument finally runs a task to update the various table entries associated with the front panel display and serial outputs.

Setup Mode

The setup mode is password protected by means of a numeric lock out code established by the user. In addition, a secret, manufacturers numeric unlock entry sequence is available.

The system also provides a minimum implementation of an "audit trail" which tracks significant setup changes to the unit. This feature is increasingly being found of benefit to users or simply required by Weights and Measurement Officials in systems used in commerce, trade, or "custody transfer" applications.

A Worksheet is provided to assist the user in setting up the instrument. An Easy Setup (EZ Setup) feature is offered in the setup menu. The EZ Setup routine is a quick and easy way to configure the unit for the most commonly used instrument functions.

The setup mode has numerous subgrouping of parameters needed for flow calculations. There is a well conceived hierarchy to the setup parameter list. Selections made at the beginning of the setup affect offerings further down in the lists.

In the setup mode, the flow computer activates the correct setup variables based on the instrument configuration, the flow equation, and the hardware selections, the flow transmitter type, and meter enhancements (linearization) options selected. All required setup parameters are enabled. All setup parameters not required are suppressed.

A help line prompt is provided for each entry. In addition a help message is available which may be accessed by depressing the "HELP" key.

Also note that in the setup mode are parameter selections which have preassigned industry standard values. The unit will assume these values unless they are modified by the user.

Maintenance (Test) Mode:

The Maintenance Mode of the 926-ST1LE provides a number of specialized utilities required for instrument checkout on start-up, setup documentation and data logger access.

A password is required to gain access to this specialized mode of operation. Quality and maintenance personnel will find this mode of operation very useful. It is also useful for factory testing.

Many of these tests may be used during start-up of a new system. Inputs signals may be read, and output signals may be exercised to verify the electrical interconnects before the entire system is put on line.

The following action items may be performed in the Maintenance Mode:

- Print Setup Report
- Examine Audit Trail
- Examine Error History
- Perform Keypad Checkout
- Perform Display Checkout
- Perform Pulse Input Checkout
- Perform Pulse Output Checkout
- Perform Control Input Checkout
- Perform Relay Output Checkout
- Perform Analog Output Checkout
- Calibrate Analog Output using the Learn Feature
- Perform Excitation Output Test
- Examine or Dump Data Logger

RS-232 Serial Port

The 926-ST1LE has a general purpose RS-232 Port which may be used for any one of the following purposes:

- Transaction Printing
- Data Logging
- Remote Metering by Modem (optional)
- Computer Communication Link
- Configuration by Computer
- Print System Setup
- Print Malfunction History

Operation of Serial Communication Port with Printers

926-ST1LE's RS-232 channel supports a number of operating modes. One of these modes is intended to support operation with a printer in metering applications requiring transaction printing, data logging and/or printing of maintenance reports.

For transaction printing, the user defines the items to be included in the printed document. The user can also select what initiates the transaction print generated as part of the setup of the instrument. The transaction document may be initiated via a front panel key depression, a remote contact closure, upon completion of a batch, time of day or at a timed interval.

In data logging, the user defines the items to be included in each data log as a print list. The user can also select when or how often he wishes a data log to be made. This is done during the setup of the instrument as either a time of day or as a time interval between logging.

The system setup and maintenance report lists all the instrument setup parameters and usage for the current instrument configuration. In addition, the Audit trail information is presented along with a status report listing any observed malfunctions which have not been corrected.

The user initiates the printing of this report at a designated point in the menu by pressing the requested key on the front panel.

Operation of Serial Port with Modems (optional)

The 926-ST1LE RS-232 channel supports a number of operating modes. One of these modes is intended to support operation with a modem in remote metering applications.

An external modem is intentionally being used with the 926-ST1LE. This permits use with the variety of modem standards worldwide while avoiding the specialized approvals required for equipment that is deemed to fall under the category of telecommunication equipment.

In the modem mode, the 926-ST1LE is assumed to be operating in a remote metering role. In addition, the 926-ST1LE will be capable of initiating a call to a designed telephone number in the event of a metering malfunction.

2. Installation

2.1 General Mounting Hints:

The 926-ST1LE Flow Computer should be located in an area with a clean, dry atmosphere which is relatively free of shock and vibration. The unit is installed in a 5.43" (138mm) wide by 2.68" (68mm) high panel cutout. (see Mounting Dimensions) To mount the Flow Computer, proceed as follows:

- a. Prepare the panel opening.
- b. Slide the unit through the panel cutout until the it touches the panel.
- c. Install the screws (provided) in the mounting bracket and slip the bracket over the rear of the case until it snaps in place.
- d. Tighten the screws firmly to attach the bezel to the panel. 3 in. lb. of torque must be applied and the bezel must be parallel to the panel.

Termination Connectors:

- Minimum Wire Gauge: 22 AWG
- Maximum Wire Gauge: 14 AWG
- Voltage/current limits are limited by unit specifications.

Permanently Connected Equipment:

UL 3101-1, Section 6.12.2.1 specifies that:

- A switch or circuit breaker shall be included in the building installation;
- It shall be in close proximity to the equipment and within easy reach of the OPERATOR;
- It shall be marked as the disconnecting device for the equipment.

NOTE: Ensure that the switch or circuit breaker chosen is suitable for the power requirements of the unit.

2.2 Mounting Diagrams:



IMPORTANT!

To provide protection type IP65/NEMA 4X, the unit must be mounted with the bezel adaptor and the gasket (supplied with the mounting kit). The bezel must be glued to the unit with silicon.

(see Instructions supplied with the mounting kit)

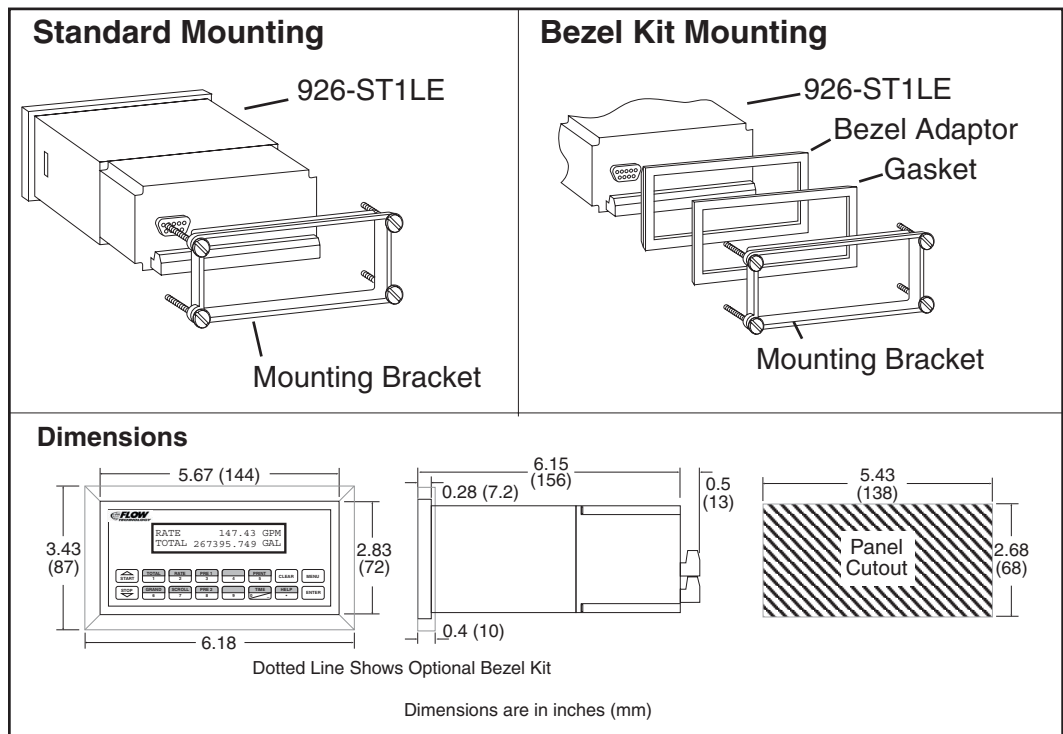

3. Applications

3.1 Liquid Volume

Measurements:

A flowmeter measures the actual volume in a liquid line.

Calculations:

- For Flowmeters with Pulse Outputs, Volume flow is calculated using the flowmeter frequency output and the user entered K-Factor or Linearization Table.

Output Results:

- Display Results
Flow Rate, Resettable Total, Non-Resettable Total
- Pulse Output
Total
- Analog Output
Rate or Total
- Relay Outputs
Rate or Total Alarms

Applications:

The Flow Computer can monitor actual volume flow and total of any liquid. Flow alarms are provided via relays and datalogging is available via serial outputs.

Liquid Volume Illustration

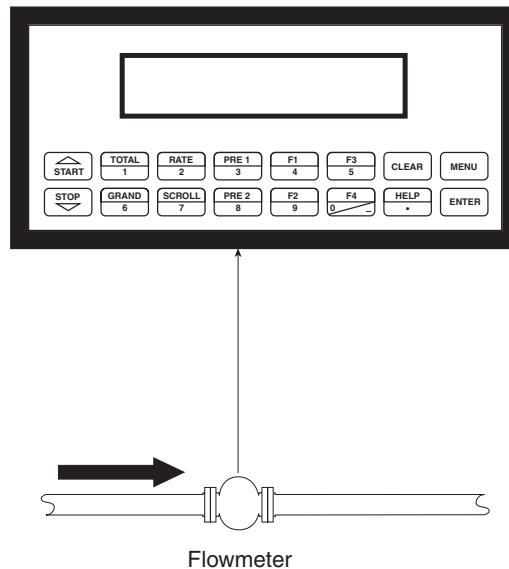

Calculations

Pulse Input; Average K-Factor or Linearization Table

$$\text{Volume Flow} = \frac{\text{input frequency} * \text{time scale factor}}{\text{K-Factor}}$$

3.2 Batching

Measurements:

A flowmeter measures the actual volume in a liquid line.

Calculations:

- For Flowmeters with Pulse Outputs, Volume flow is calculated using the flowmeter frequency output and the user entered K-Factor or Linearization Table.

Output Results:

- Display Results
Flow Rate, Batch Total, Non-Resettable Total
- Pulse Output
Total
- Analog Output
Rate or Total
- Relay Outputs
Batch Total, Rate, or Alarms

Applications:

Batching and monitoring flow and total of any liquid. Batching is accomplished via relays and datalogging is available via serial outputs.

Batching Illustration

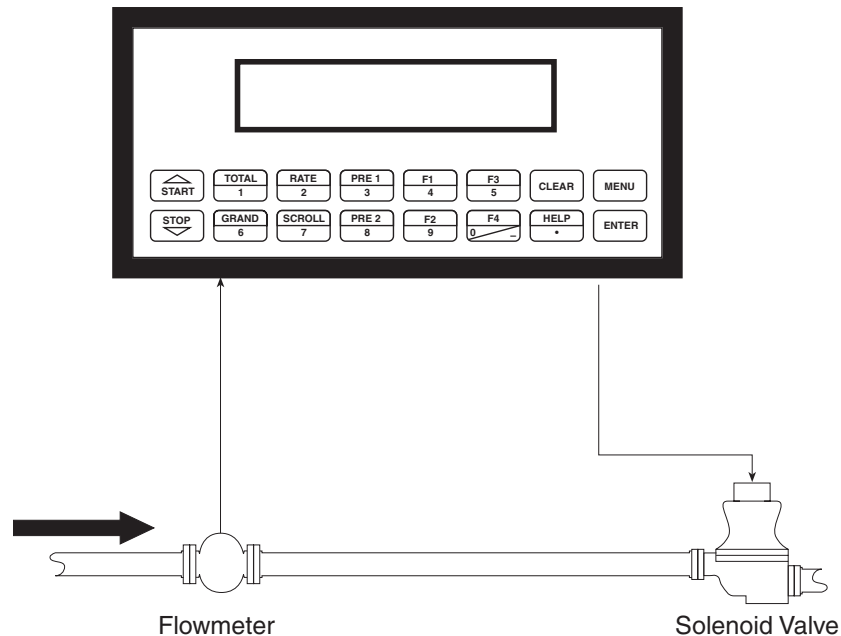

Calculations

Pulse Input: Average K-Factor or Linearization Table

$$\text{Volume Flow} = \frac{\text{input frequency} * \text{time scale factor}}{\text{K-Factor}}$$

4 WIRING

4.1 Typical Batcher Wiring:

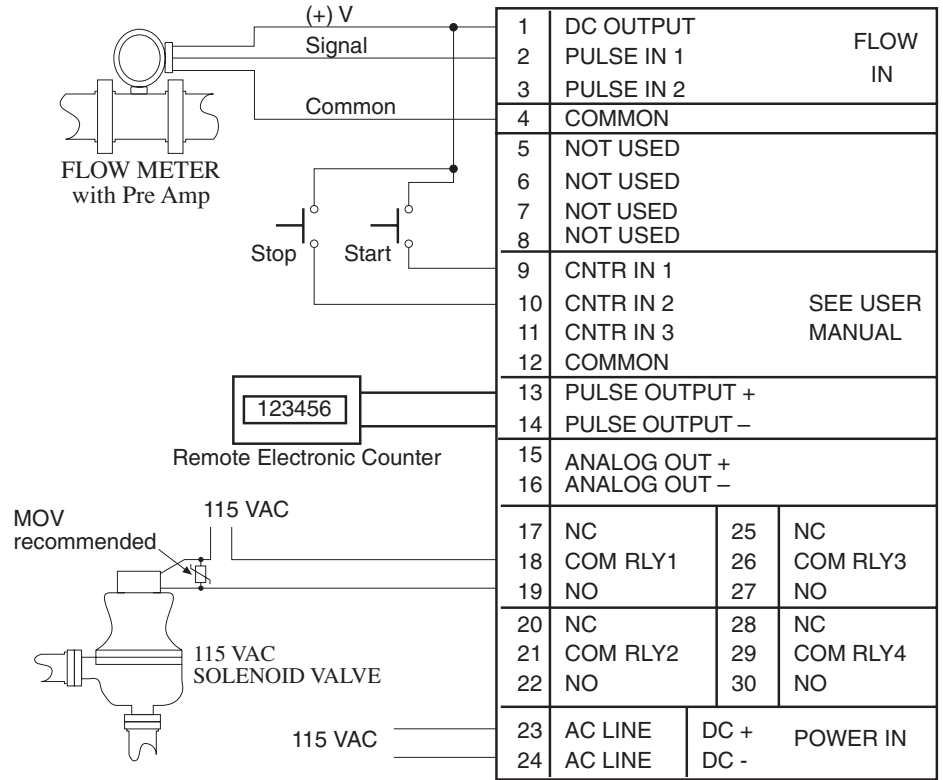

4.2 Typical Rate/Total Wiring:

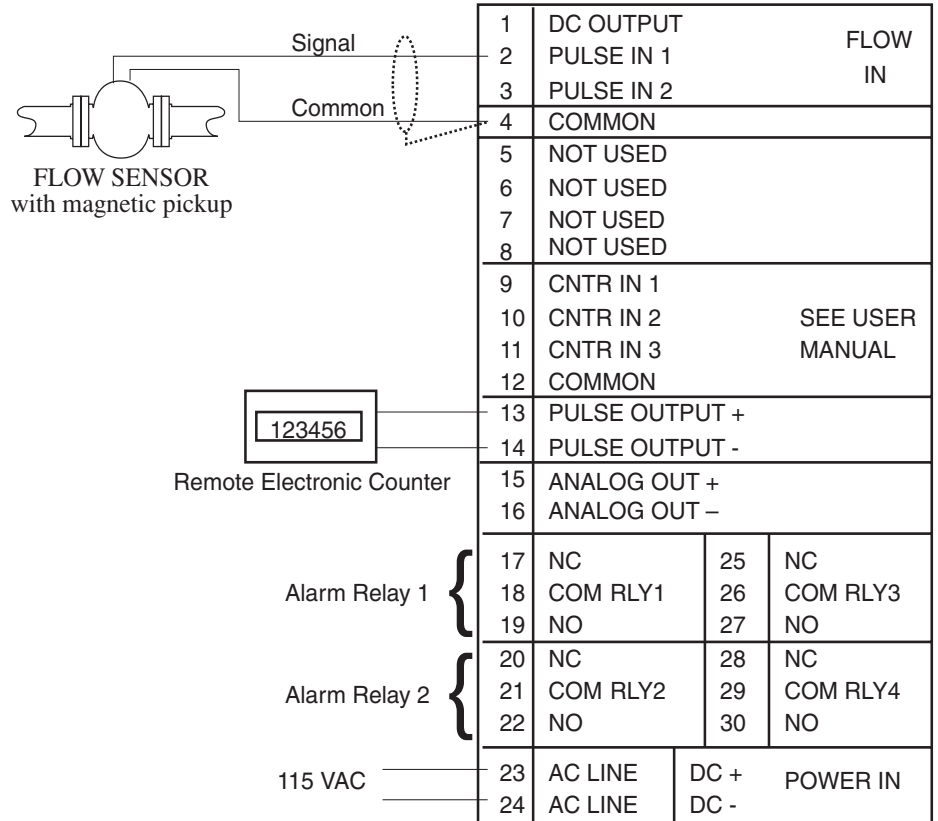

5. UNIT OPERATION

5.1 Front Panel Operation Concept for Run Mode

The 926-ST1LE is fully programmable through the front panel. Please review the following usage summary before attempting to use the instrument.

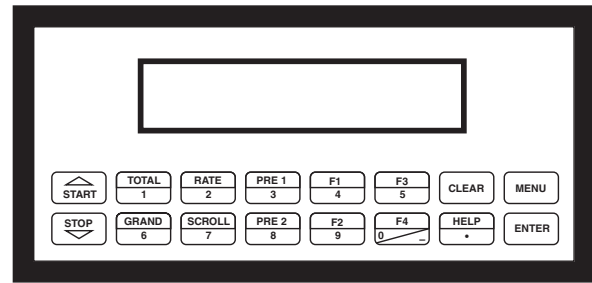

HELP

On-line help is provided to assist the operator in using this product. The help is available during RUN and SETUP modes simply by pressing the HELP key. The HELP key is used to enter decimals when entering numeric values.

FUNCTION KEYS

In the RUN mode, several keys have a special, direct access feature, to display an item of interest (i.e. RATE, TOTAL, PRE 1, etc.). Press the key to view your choice. Press the SCROLL key to return to scrolling display.

CLEARING TOTALIZER

To clear the total, you must press the TOTAL Function Key 3 times quickly to select the total. Once the total is selected, press the CLEAR key to reset the total. The operator will be prompted to enter password if the unit is locked.

NOTE: In the Batcher Mode, simply press the CLEAR key to reset the total (the batcher must be stopped or finished batching). It is not necessary to press the TOTAL Function Key first.

CLEARING GRAND TOTAL

To clear the grand total, you must press the GRAND Function Key 3 times quickly to select the grand total. Once the grand total is selected, press the CLEAR key to reset the grand total. The operator will be prompted to enter password if the unit is locked.

PRESET KEYS

In the RUN mode, PRE 1, PRE 2, F1 and F2 keys are used to view and/or change the preset setpoints. To view the Presets, simply press the desired Preset key once. Rapidly press the Preset keys 3 times, then press the Clear key for direct editing of the preset setpoints.

SCROLL

Rapidly press the Scroll key 3 times to setup a display list.

Press the CLEAR key to remove old scroll list.

Press the function key for the item you wish to add

Use the Δ ∇ keys to assign the line.

Press the ENTER key to save scroll list.

PRINT

The PRINT key is used to print on demand. When the PRINT key is pressed, a user defined list of data (TOTAL, RATE, PRE 1, etc.) is sent to the RS232 port. A timed message of "PRINTING" will be displayed to acknowledge the print request.

SPECIAL BATCHING KEYS

The START and STOP keys are used only when batching to start and stop batches. The CLEAR key will clear the total without first pressing the TOTAL key (unit must be stopped). All other keys work the same in both Rate/Total mode and Batch mode. The Start and Stop keys operation are set by the control input settings. The Start options are: START or RESET/START. The Stop options are: STOP or STOP/RESET.

MENU KEY

The MENU key is used to enter the Setup and Test modes. Press the MENU key to enter the Setup and Test modes. The user will be prompted to enter a password if the unit is locked. (See section 6 for Setup mode, section 8 for Test mode). The MENU key is also used as "escape" in Setup and Test Programming. Pressing the MENU key while programming in the Sub-Menu groups will backup the display to that Sub-Menu group heading. Pressing the MENU key while viewing the Sub-Menu groups will backup the display to the Top Level Menu.

ACKNOWLEDGING ALARMS

Most alarm messages are self-clearing. Press the ENTER key to acknowledge and clear alarms.

NOTE: Some keys and functions are password protected. Enter the password to gain access. The passwords are factory set as follows: Operator = 0; Supervisor = 2000

TIME/DATE

The TIME key is reserved for displaying Time and Date. To View the Time or Date, press the TIME key once.

5.2 General Operation

The unit can display: Rate, Total, Grand Total, Presets and Time of Day. The unit can be programmed to perform Ratemeter/Totalizer or Batching functions.

5.3 Ratemeter/Totalizer Operation

The Ratemeter/Totalizer mode is used primarily to monitor flowrate and accumulated total. The relays can be used to trigger on flow rate, total, or alarms.

5.3.1 Password Protection for Rate/Total mode

After an Operator and/or Supervisor Password is entered in the setup mode (see section 6.3, SETUP PASSWORD submenu), the unit will be locked. The unit will prompt the user for the password when trying to perform the following functions:

- Clear Total
- Clear Grand Total
- Enter Menu
- Edit Preset 1 (PRE 1 Key)
- Edit Preset 2 (PRE 2 Key)
- Edit Preset 3 (4 Key)
- Edit Preset 4 (9 Key)

The Supervisor password should be reserved for supervisors. The Supervisor password will allow access to restricted areas of the Setup and Test menus.

5.3.2 Relay Operation in Rate/Total mode

Up to four relays are available (two standard) for alarm outputs. The relays can be assigned to trip according to rate, total or general system alarms. The relays can be programmed for low or high alarms. Preset 1 (RLY1) and Preset 2 (RLY2) are easily accessible by pressing the PRE 1 or PRE 2 key on the front panel. Preset 3 and Preset 4 are accessible by pressing the 4 or 9 keys.

5.3.3 Pulse Output in Rate/Total mode

The isolated pulse output (open collector) is assigned to Volume Total. The pulse output duration can be set for 10mS (50 Hz max) or 100mS (5 Hz max). A pulse output scale factor (pulse value) can be set to scale the pulse output. The pulse output is ideal for connecting to remote totalizers or other devices such as a PLC. See section 1.3 for electrical specifications.

5.3.4 Analog Output in Rate/Total mode

The analog output is menu assignable to correspond to the Volume Rate or Volume Total. The analog output is ideal for "trend" tracking using strip chart recorders or other devices.

5.3.5 RS-232 Serial Port Operation in Rate/Total mode

The RS-232 serial port can be used for programming (using the Setup Disk) or for communicating to printers and computers in the Operating Mode (Run Mode).

PC Communications:

The Setup Disk also allows the user to query the unit for operating status such as Flow Rate, Flow Total, Presets, etc.

Operation of RS-232 Serial Port with Printers:

Transaction Printing

For transaction printing, the user defines the items to be included in the printed document (see section 6.3.20 SET DATA OUTPUT, Select_list). The transaction document can be initiated by pressing the PRINT key or by a remote contact closure.

Data Logging

In data logging, the user defines the items to be included in each data log (see section 6.3.20 SET PRINTER OUTPUT, Select_list). The user can also select when (time of day) or how often (print interval) the data log is to be made (see section 6.3.19 SET PRINTER OUTPUT, Configure).

System Setup and Maintenance Report

The system setup and maintenance report lists all of the instrument setup parameters and usage for the current instrument configuration. The audit trail information and a status report is also printed. This report is initiated in the Test menu (see section 8.2.3 PRINT SYSTEM SETUP).

5.3.6 RS-485 Serial Port (optional)

RS-485 Port Description:

The optional RS-485 card utilizes Modbus RTU protocol to access a variety of process parameters and totalizers. The Relays can be controlled via Modbus. In addition, action routines can be executed. For further information, contact factory and request RS-485 Protocol manual.

Operation of Serial Communication Port with PC

The flow computer's RS-485 channel supports a number of Modbus RTU commands. Modbus RTU drivers are available from third party sources for a variety of Man Machine Interface software for IBM compatible PC's.

The user reads and writes information from/to the RS-485 using the Modbus RTU commands. The 926-ST1LE then responds to these information and command requests.

Process variables and totalizers are read in register pairs in floating point format. Time and date are read as a series of integer register values. Alarms are individually read as coils. Action routines are initiated by writing to coils.

5.4 Batcher Operation

The Batcher mode is used primarily to control batches. The main difference between the Batch mode and Rate/Total mode is the relay operation. The Batch mode allows the operator to "START" the unit via the front panel or remote input. Once started, the relays (RLY1 & RLY2) will energize and send a contact to a flow control device (i.e. solenoid valve or pump). The flow sensor will send a signal to the unit and total accumulation will begin. Just before the end of batch, when the Prewarn value (PRE 2) is reached, Relay 2 will drop out (this is ideal for flow slow down). When the final Batch amount (PRE 1) is reached, Relay 1 will drop out and the Batch is complete.

Several messages will be displayed during normal batch operation (i.e. Batch Fill, Batch Stopped). The keypad is disabled for the duration of these timed messages (approx. 2 sec).

5.4.1 Batcher Configuration.

When the unit is programmed for batch mode, several batch operation choices are available. These choices include: EZ Preset, Up or Down Counting, Maximum Batch Preset, Batch Overrun Compensation, Auto Batch Restart, Time Delay, Flow Signal Timeout, Maximum Drain Time, Slow Start Quantity, Start or Reset/Start, and Stop or Stop/Reset.

EZ Preset

A selectable mode of batching where user can press "PRE 1", then "ENTER" then the quantity to be batched, then "START" for a quick enter-start sequence.

Batch Count Mode

The Batch Count Mode allows the user to choose whether the unit will batch up to a preset value or batch down from a preset value to zero.

Maximum Batch Preset

The Maximum Batch Preset allows the user to program the Maximum Batch value allowed to be entered by the operator. If an operator should try to program a batch higher than this value, the unit will not allow the value to be entered and will prompt the user with an error message saying that the permitted Maximum Batch Preset size has been exceeded.

Batch Overrun

The Batch Overrun is used for batch applications that have slow responding valves and a consistent batching flowrate. When the Batch Overrun is set, the unit will compensate for batch overruns by computing an averaged overrun value from the last four batches. This average is used to internally adjust the batch setpoint to minimize overrun. The maximum drain time must be set greater than the slowest valve response time for proper operation of this feature.

Auto Batch Restart

The Auto Batch Restart function allows the user to set an amount of time to automatically restart a batch after the completion of a batch. This time can be set from 1 to 99 seconds.

Flow Signal Timeout

The Flow Signal Timeout allows the user to enter a timeout of 0 to 99 seconds. If a batch is "Filling" and zero flow persists for more than the user entered time then the batch will be aborted. This prevents over flows due to faulty flow sensors and/or wiring.

Maximum Drain Time

The unit declares that a batch is "done" when the flow rate equals "0". A flow rate may be present long after the Preset Relay de-energizes due to slow reacting valves or leaky valves. The Maximum Drain Time allows the user to enter an amount of time (0 to 99 seconds) to wait before declaring "Batch Done". After the Preset Batch quantity is reached, the unit will declare "Batch Done" when the flow rate is "0" or the Maximum Drain Time has expired. The batch data will then be available for printing and datalogging.

Slow Start Quantity

The Slow Start Quantity is a function that allows an amount to be entered for a Slow Start of fill. This function requires two stage valve control. RLY 1 (slow flow) will energize for Slow Start and RLY 2 (fast flow) will energize after the Slow Start Quantity has been delivered. This helps reduce turbulence when filling an empty container.

START, RESET/START and STOP, STOP/RESET

When configuring the control inputs, Control Input1 can be set for START or RESET/START. When set for START, the unit will start batching when a signal is applied to Control Input 1 or the front panel Start key is pressed. A separate Reset signal or CLEAR key depression must be used to clear the previous batch total. When set for RESET/START, the unit will automatically reset then start when a signal is applied to Control Input1 or the front panel Start key is pressed (provided that the pervious batch was completed). If a previous batch was stopped during a batch cycle, the unit will Start from where it was stopped.

Control Input 2 can be set for STOP or STOP/RESET. When set for STOP, the unit will stop batching when a signal is applied to Control Input 2 or the front panel Stop key is pressed. A separate Reset signal or CLEAR key depression must be used to clear the batch total. When set for STOP/RESET, a running batch will stop when a signal is applied to Control Input 2 or the front panel Stop key is pressed. If the unit is Stopped or after a completed batch, the unit will reset when a signal is applied to Control Input 2 or the front panel Stop key is pressed.

NOTE: Applying a voltage level to Control Input 2 will inhibit and override all Start inputs in either mode.

5.4.2 Password Protection for Batcher Mode

After an Operator and/or Supervisor Password is entered in the setup mode (see section 6.3, SETUP PASSWORD Sub-menu), the unit will be locked. The unit will prompt the user for the password when trying to perform the following functions:

- Clear Grand Total
- Enter Menu

The Supervisor password should be reserved for supervisors. The Supervisor password will allow access to restricted areas of the Setup and Test menus.

The passwords are factory set as follows:

- Operator = 0
- Supervisor = 2000

NOTE: A password of "0" should not be used since it will leave the unit unlocked and open to accidental changes.

5.4.3 Relay Operation in Batcher mode

Up to four relays are available (two standard) for alarm outputs. Preset 1 (RLY1) is reserved for batch amount, Preset 2 (RLY2) is reserved for prewarn. (see section 5.4 Batcher Operation for Relay 1 & Relay 2 functions)

Preset 1 (RLY1) and Preset 2 (RLY2) are easily accessible by pressing the PRE 1 or PRE 2 key on the front panel. Preset 3 and Preset 4 are accessible by pressing the 4 or 9 keys.

Relays 3 and 4 can be assigned to trip according to rate, total, overrun or alarm. When Rate is selected the relays can be programmed for low or high alarms. When N.A (not assigned) is selected, the relays may be tripped via serial commands. Alternately, Preset 2, 3 or 4 may be used to enter alternate information and can be printed in the print list for transaction history.

5.4.4 Pulse Output in Batcher mode

The isolated pulse output (open collector) is assigned to Volume Total. The pulse output duration can be set for 10mS (50 Hz max) or 100mS (5 Hz max). A pulse output scale factor (pulse value) can be set to scale the pulse output. The pulse output is ideal for connecting to remote totalizers or other devices such as a PLC. See section 1.3 for electrical specifications.

5.4.5 Analog Output in Batcher mode

The analog output is menu assignable to correspond to the Volume Rate or Volume Total. The analog output is ideal for "trend" tracking using strip chart recorders or other devices.

5.4.6 RS-232 Serial Port Operation in Batch mode

The RS-232 serial port can be used for programming (using the Setup Disk) or for communicating to printers and computers in the Operating Mode (Run Mode).

PC Communications:

The Setup Disk also allows the user to query the unit for operating status such as Flow Rate, Flow Total, Presets, etc.

Operation of RS-232 Serial Port with Printers:

Transaction Printing

For transaction printing, the user defines the items to be included in the printed document (see section 6.3.20 SET DATA OUTPUT, Select_list). The transaction document can be initiated by pressing the PRINT key, by a remote contact closure or print at end of batch.

Data Logging

In data logging, the user defines the items to be included in each data log (see section 6.3.20 SET PRINTER OUTPUT, Select_list). The user can also select when (time of day) or how often (print interval) the data log is to be made (see section 6.3.19 SET PRINTER OUTPUT, Configure).

System Setup and Maintenance Report

The system setup and maintenance report lists all of the instrument setup parameters and usage for the current instrument configuration. The audit trail information and a status report is also printed. This report is initiated in the Test menu (see section 8.2.3 PRINT SYSTEM SETUP).

5.4.7 RS-485 Serial Port (optional)

RS-485 Port Description:

The optional RS-485 card utilizes Modbus RTU protocol to access a variety of process parameters and totalizers. Batches/Relays can be controlled remotely via Modbus. In addition, action routines can be executed. For further information, contact factory and request RS-485 Protocol manual.

Operation of Serial Communication Port with PC

The flow computer's RS-485 channel supports a number of Modbus RTU commands. Modbus RTU drivers are available from third party sources for a variety of Man Machine Interface software for IBM compatible PC's.

The user reads and writes information from/to the RS-485 using the Modbus RTU commands. The 926-ST1LE then responds to these information and command requests.

Process variables and totalizers are read in register pairs in floating point format. Time and date are read as a series of integer register values. Alarms are individually read as coils. Action routines are initiated by writing to coils.

6. PROGRAMMING

6.1 Front Panel Operation Concept for Program Mode

The 926-ST1LE is fully programmable through the front panel. Please review the following usage summary before attempting to use the instrument.

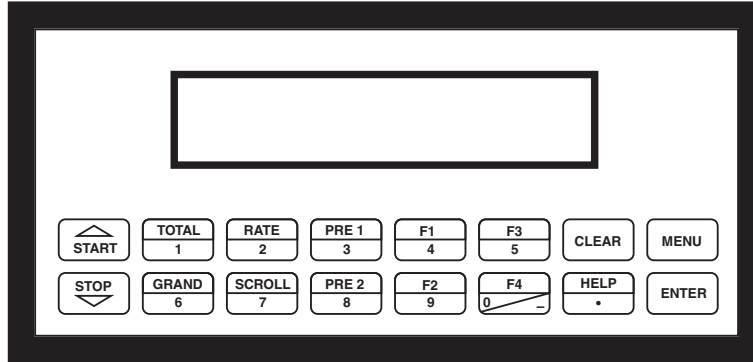

Setup Mode:

MODE CHANGES

Pressing the MENU key will offer selections of RUN, SETUP, TEST. RUN is the normal operating mode for the instrument. SETUP offers various sub-menus used for instrument setup. TEST offers various sub-menus for Test, Calibration and System Start-up testing.

Sub-menu GROUP NAVIGATION

Use the UP and DOWN arrow keys to navigate up and down through the Sub-Menu groups when in the SETUP or TEST mode. Press the ENTER key to enter a desired setup or test Sub-Menu group.

SELECTION OF ITEM

During setup, the unit will often offer multiple choices for a given topic. The topic prompt appears on the top line of the display. The choices are shown on the lower line of the display.

To select an item, press the key (in top row) beneath the desired choice. The selected choice will blink. Press the ENTER key to accept the selected choice.

NUMERIC ENTRY

The keys labeled "0 - 9", "-", ".", CLEAR and ENTER are used to enter numerical values. A leading 0 will assume that you intend to enter a minus "-" sign. Press the CLEAR key to clear the existing value and to enable editing. Enter the digits of your desired values, press ENTER to accept the value.

TEXT CHARACTER ENTRY

Some setup items (i.e. Descriptors, Units Label) require the user to enter text characters. Press CLEAR to enable editing. The UP and DOWN arrow keys are used to scroll through the available character sets for each individual character. Press the ENTER key to accept the character and advance to the next character.

6.2 EZ Setup

The EZ Setup routine is a quick and easy way to configure the unit for the most commonly used instrument functions. This setup assumes that you are measuring Volumetric Flow using a high level, DC Pulsing flow sensor. Entering the EZ Setup mode automatically sets many features. This may cause any previously programmed information to be lost or reset. For a complete customized configuration, see sections 6.3 and 6.4.

Menus	Display	Notes
6.2.1 TOP LEVEL SETUP MENU	<pre>SELECT OPERATE STATE Run Setup Test ENTER ↓</pre>	Select Setup to enter the instrument setup routine.
6.2.2 EZ Setup Sub-menu Groups	<pre>SELECT EZ SETUP ENTER ↓</pre>	Press ENTER to begin EZ Setup routine.
	<pre>CHANGES ALL SETUPS ! No Yes ENTER ↓</pre>	Confirm that you want to run EZ Setup. Caution: Any previous program settings may be lost or reset.
	<pre>INSTRUMENT TYPE Rate/Tot Batch ENTER ↓</pre>	Instrument Type.
	<pre>RATE TIME BASE Sec Min Hour Day ENTER ↓</pre>	Select the appropriate rate time base.
	<pre>RATE DEC PLACES(0-4) 0 ENTER ↓</pre>	Enter the desired rate decimal location. 0-4 decimal places allowed.
	<pre>TOTAL VOLUME UNITS gal ENTER ↓</pre>	Enter the desired totalizer units label.
	<pre>TOT DEC PLACES (0-3) 0 ENTER ↓</pre>	Enter the desired totalizer decimal location. 0-3 decimal places allowed.
	<pre>K_FACTOR TYPE Avg LinTbl ENTER ↓</pre>	Enter the desired K-Factor Type.
	<pre>AVERAGE KA-FACTOR ##### P/gal ENTER ↓</pre>	If Average selected, Enter the desired Average K-Factor.
	<pre>LINEAR TABLE KA Fre01:##### Hz ENTER ↓</pre>	If LinTbl selected, Enter the desired frequency/ K-Factor pair for each point in the Linearization Table.
	<pre>LINEAR TABLE KA KA--01:##### ENTER ↓</pre>	Enter a frequency of 0 for any point other than Fre01 to exit Linearization Table setup.
	<pre>FS ANALOG OUT 20mA #####gal/m ENTER ↓</pre>	Enter the desired full scale setting for the analog output.
	<pre>RATE 00.0 gal/m TOTAL 0 gal</pre>	Return to Run Mode

Through 16 Points

6.3 Setup Menus

Sub-menus	Display	Notes
6.3.1 Top Level Setup Menu	<pre> SELECT OPERATE STATE Run Setup Test ↑ MENU ENTER ↓ </pre>	Select Setup to enter the instrument setup routine.
6.3.2 Sub-menu Groups	<pre> SELECT EZ SETUP ↓ STOP ↑ START </pre>	Refer to Page 17 for Details.
	<pre> INSTRUMENT TYPE ↓ STOP ↑ START </pre>	Refer to Page 19 for Details
	<pre> SETUP INDICATORS ↓ STOP ↑ START </pre>	Refer to Page 21 for Details.
	<pre> SETUP FLOW INPUT ↓ STOP ↑ START </pre>	Refer to Page 22 & 23 for Details.
	<pre> SETUP PULSE OUTPUT ↓ STOP ↑ START </pre>	Refer to Pages 24 for Details.
	<pre> SETUP ANALOG OUTPUT ↓ STOP ↑ START </pre>	Refer to Pages 24 for Details.
	<pre> SETUP RELAYS ↓ STOP ↑ START </pre>	Refer to Page 25 & 26 for Details.
	<pre> SETUP CONTROL INPUTS ↓ STOP ↑ START </pre>	Refer to Page 27 for Details.
	<pre> SETUP REALTIME CLOCK ↓ STOP ↑ START </pre>	Refer to Page 28 for Details.
	<pre> SERIAL USAGE ↓ STOP ↑ START </pre>	Refer to Page 29 for Details.
	<pre> SETUP DATALOG/PRINT ↓ STOP ↑ START </pre>	Refer to Pages 30 & 31 for Details.
	<pre> ADMINISTRATIVE SETUP ↓ STOP ↑ START </pre>	Refer to Page 31 for Details.
	<pre> SETUP NETWORK CARD ↓ STOP ↑ START </pre>	Refer to Page 32 for Details. (Setup Network Card menu will only appear on units equipped with a network card)

6.4 Setup Sub-Menus

Sub-menus

Display

Notes

6.4.1 SELECT EZ SETUP

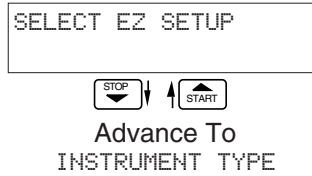

Refer to page 17 for EZ Setup routine.

Press the DOWN (stop) key to advance to Instrument Type. Press the UP (start) key to advance to Administrative Setup.

6.4.2 INSTRUMENT TYPE

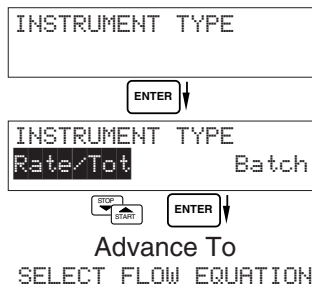

Press ENTER to enter Instrument Type sub-menus.

Press ENTER when Rate/Total is flashing to configure the instrument as a Ratemeter/Totalizer.

Rate/Tot

If Rate/Tot selected, advance to Setup Indicators.

Batch

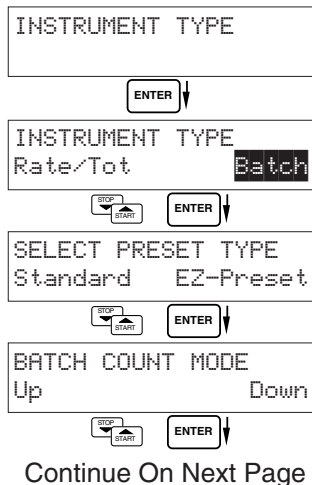

Press ENTER to enter Instrument Type sub-menus.

Press ENTER when Batch is flashing to configure the instrument as a Batch.

Select Standard for standard preset operation. Select EZ-Preset for quick preset editing mode. (see section 5.4.1 Batch Configuration.)

Select UP to Reset to 0 and count up to preset. Select DOWN to reset to Preset and count down to 0.

Sub-menus

Notes

6.4.2 INSTRUMENT TYPE (continued)

See Section 5.4, see also Max. Drain Time note.

NOTE: Max Drain time value must be greater than the slowest valve response time when using Batch Overrun Comp.

MAXIMUM BATCH PRESET
1000.0 gal

STOP START ENTER

BATCH OVERRUN COMP
Off On

STOP START ENTER

AUTO BATCH RESTART
Off On

STOP START ENTER

TIME DELAY (1-99sec)
10

STOP START ENTER

FLOW SIGNAL TIMEOUT
10

STOP START ENTER

MAXIMUM DRAIN TIME
10

ENTER

SLOW START QUANTITY
10

ENTER

Advance To
SETUP INDICATORS

Enter the maximum allowable Batch Preset. The operator will not be able to enter a batch preset larger than this value.

Select ON to set the unit to operate using a Batch Overrun Compensation routine. Select OFF to inhibit Batch Overrun Compensation routine.

Select On to enable the Auto Batch Restart. This will automatically restart the unit at the end of each batch run (after programmed timeout). Select Off to disable.

Enter Time Delay for Auto Batch Restart. When a batch is completed, the next batch will start automatically after the amount of time entered here has elapsed.

Enter a timeout of 0 to 99 seconds. If a batch is "Filling" and zero flow persists for more than this time, the batch filling will be stopped.

Enter time (0-99 sec.) for Max. Drain Time. After batch quantity is reached, "Batch Done" is declared when the flow rate is "0" or the Maximum Drain Time has expired.

Enter a quantity for a Slow Start up. RLY 1 (slow flow) will energize for Slow Start and RLY 2 (fast flow) will energize after the Slow Start Quantity has been delivered. Both RLY 1 and RLY 2 are energized during "fast fill".

Sub-menus

Display

Notes

**6.4.3
SETUP
INDICATORS
(Total)**

```

SETUP INDICATORS
ENTER ↓
SETUP INDICATORS
Total Rate
ENTER ↓
TOTAL DESCRIPTOR
TOTAL
ENTER ↓
TOTAL VOLUME UNITS
gal
ENTER ↓
TOT DEC PLACES (0-3)
0
ENTER ↓
Advance To
SETUP INDICATORS
(Rate)
    
```

Press ENTER to begin setup of the Indicators

Press ENTER when Total is flashing to configure the Totalizer Indicators

Enter the desired Total Descriptor text

Enter the desired Volume Units Label text for the Totalizer.

Select the desired Total Decimal Place. 0-3 decimal places allowed.

**6.4.4
SETUP
INDICATORS
(Rate)**

```

SETUP INDICATORS
Total Rate
ENTER ↓
RATE TIME BASE
Sec Min Hour Day
ENTER ↓
RATE DESCRIPTOR
RATE
ENTER ↓
RATE DEC PLACES(0-4)
4
ENTER ↓
RATE AVG FILTER
0
ENTER ↓
QUICK UPDATE %
5
ENTER ↓
Advance To
SETUP FLOW INPUT
    
```

Press ENTER when Rate is flashing to configure the Ratemeter Indicators

Select the desired Rate Time Base.

Enter the desired Descriptor text for the Ratemeter.

Select the desired Rate Decimal Place. 0-4 decimal places allowed.

Enter desired Rate Averaging Filter. (see Definitions for more details)

Enter desired Percent of Change for Quick Update. If the current flowrate deviates by an amount greater than the percentage value entered, the Rate Averaging is inhibited.

(See Definitions for more details.)

Sub-menus

Display

Notes

**6.4.5
SETUP
FLOW INPUT**
(Pulse - chA &
chA=chB)

NOTE:
chA = Single Pulse
chA=chB = Pulse
checking
for missing
pulses
Qx1 = Quadrature
Qx2 = Quadrature x 2

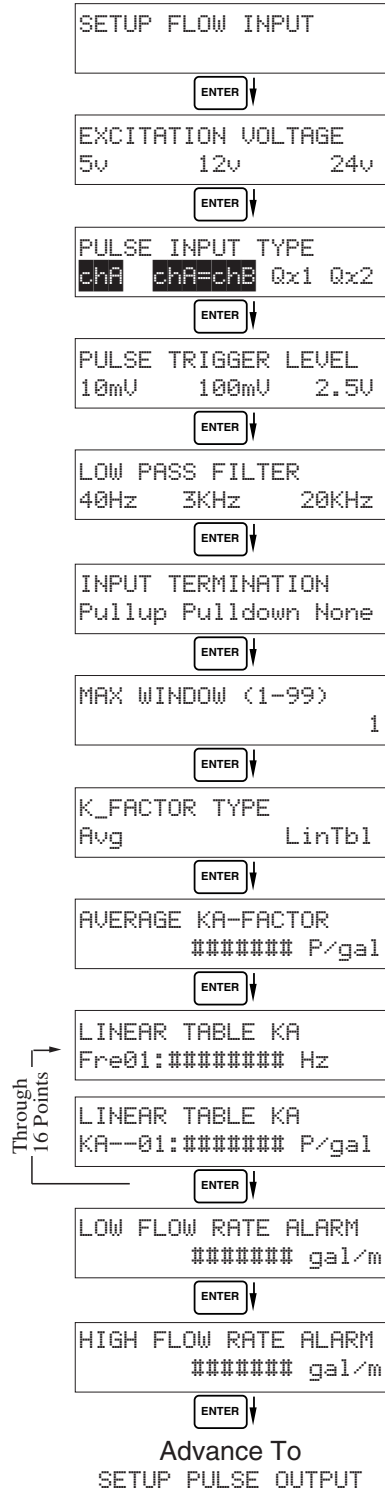

Press ENTER to begin setup of Flow Input.

Select the desired Excitation Voltage for your flow sensor. Caution: Improper selection may cause damage to sensor

Enter the desired Pulse type. See side note.

Select the desired Input Pulse Trigger Level.

Select the desired Low Pass Filter. (Max. Count Speed). Use 3KHz with turbine flowmeters.

Select the proper input termination.

Enter the desired Maximum Sample Window Time (1-99 sec) that can occur at the lowest flowrate. Use 1 second for turbine flowmeters.

Enter the desired K-Factor Type.

If Avg selected, Enter the desired Average K-Factor in the units requested.

If LinTbl selected, Enter the desired frequency/ K-Factor pair for each point in the Linearization Table.
NOTE: Enter 0 for Fre value of any point (other than Fre01) to exit the routine and use the values entered up to that point.

Enter the desired volumetric Low Rate Alarm. This will trigger an alarm message if alarm conditions occur. The relays are not affected.

Enter the desired volumetric High Rate Alarm. This will trigger an alarm message if alarm conditions occur. The relays are not affected.





Sub-menus

Display

Notes

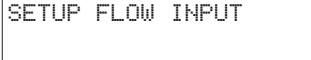
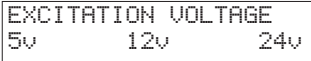
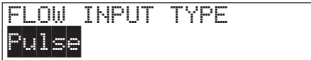
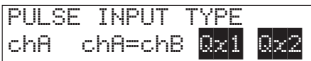
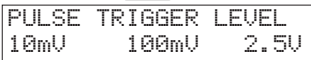
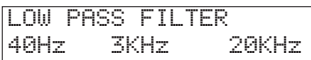
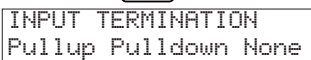
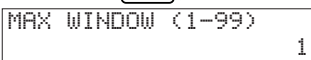
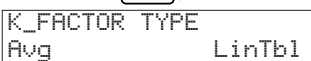
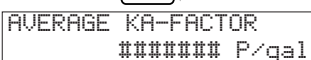
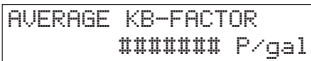
**6.4.6
SETUP
FLOW INPUT**
(Pulse - Quadrature,
Qx1 or Qx2)

NOTE:
chA = Single Pulse
chA=chB = Pulse
checking
for missing
pulses
Qx1 = Quadrature
Qx2 = Quadrature x 2

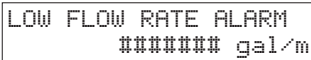
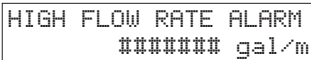
	<p>Press ENTER to begin setup of Flow Input.</p>
<p style="text-align: center;">ENTER ↓</p> 	<p>Select the desired Excitation Voltage.</p>
<p style="text-align: center;">ENTER ↓</p> 	<p>Press ENTER when Pulse is flashing to configure the flow input for Pulse signals.</p>
<p style="text-align: center;">ENTER ↓</p> 	<p>Enter the desired Pulse type. See side note.</p>
<p style="text-align: center;">ENTER ↓</p> 	<p>Select the desired Input Pulse Trigger Level.</p>
<p style="text-align: center;">ENTER ↓</p> 	<p>Select the desired Low Pass Filter. (Max. Count Speed). . Use 3kHz with turbine flowmeters.</p>
<p style="text-align: center;">ENTER ↓</p> 	<p>Select the proper input termination.</p>
<p style="text-align: center;">ENTER ↓</p> 	<p>Enter the desired Maximum Sample Window Time (1-99 sec) that can occur at the lowest flowrate. Use 1Hz for turbine flowmeters.</p>
<p style="text-align: center;">ENTER ↓</p> 	<p>Enter the desired K-Factor Type.</p>
<p style="text-align: center;">ENTER ↓</p> 	<p>If Avg selected, Enter the desired Average K-Factor (KA for channel A).</p>
<p style="text-align: center;">ENTER ↓</p> 	<p>Enter the desired Average K-Factor (KB for channel B).</p>
<p style="text-align: center;">ENTER ↓</p> 	<p>If LinTbl selected, Enter the desired frequency/ K-Factor pair for each point in the Linearization Table. (channel A)</p>
<p style="text-align: center;">ENTER ↓</p> 	<p>NOTE: Enter 0 for Fre value of any point (other than Fre01) to exit the routine and use the values entered up to that point.</p>
<p style="text-align: center;">ENTER ↓</p> 	<p>Enter the desired frequency/ K-Factor pair for each point in the Linearization Table. (channel B)</p>
<p style="text-align: center;">ENTER ↓</p> 	<p>NOTE: Enter 0 for Fre value of any point (other than Fre01) to exit the routine and use the values entered up to that point.</p>
<p style="text-align: center;">ENTER ↓</p> 	<p>Enter the desired volumetric Low Rate Alarm. This will trigger an alarm message if alarm conditions occur. The relays are not affected.</p>
<p style="text-align: center;">ENTER ↓</p> 	<p>Enter the desired volumetric High Rate Alarm. This will trigger an alarm message if alarm conditions occur. The relays are not affected.</p>
<p style="text-align: center;">ENTER ↓</p> <p style="text-align: center;">Advance To SETUP PULSE OUTPUT</p>	

Sub-menus	Display	Notes
<p>6.4.7 SETUP PULSE OUTPUT</p>	<pre> SETUP PULSE OUTPUT [ENTER] PULSE OUTPUT USAGE Off Volume [ENTER] PULSE WIDTH 10mS 100mS [ENTER] PULSE VALUE 1000 gal/P [ENTER] Advance To SETUP ANALOG OUTPUT </pre>	<p>Press ENTER at this prompt to setup the Pulse Output.</p> <p>Select the desired Pulse Output Usage.</p> <p>Select the desired Pulse Width for the Pulse Output.</p> <p>Enter the desired Pulse Value for the Pulse Output (Volume Units per Pulse).</p>
<p>6.4.8 SETUP ANALOG OUTPUT</p>	<pre> SETUP ANALOG OUTPUT [ENTER] ANALOG OUTPUT USAGE Rate Total [ENTER] ANALOG OUTPUT RANGE 4-20mA 0-20mA [ENTER] LS ANALOG OUTPUT 0.0 gal/m [ENTER] FS ANALOG OUT 20mA 1000.0 gal/m [ENTER] ANALOG OUT DAMPING 0.0 [ENTER] Advance To SETUP RELAYS </pre>	<p>Press ENTER when Analog is flashing to setup the Analog Output.</p> <p>Select the desired Analog Output Usage.</p> <p>Select the desired current range for the Analog Output.</p> <p>Enter desired Analog Output Low Scale Value. NOTE: Units label will correspond with output usage type selected.</p> <p>Enter desired Analog Output Full Scale Value.</p> <p>Enter the desired Analog Output Damping Constant. See Definitions for additional information.</p>

Sub-menus

Display

Notes

**6.4.9
SETUP RELAYS
(Relay 1 & Relay 2)**

NOTE:

In Batch mode,
Relay 1 is reserved
for Preset,
Relay 2 is reserved
for Prewarn or NA
(not assigned).

```

SETUP RELAYS
R1y1 R1y2 R1y3 R1y4
    
```

ENTER ↓

```

RELAY 1  USAGE
RATE    TOTAL    NA
    
```

ENTER ↓

```

RELAY 1 DELAY    sec
                    0
    
```

ENTER ↓

```

RELAY 1 DURATION
                    #####
    
```

ENTER ↓

```

RELAY 1 MODE
LO_ALARM  HI_ALARM
    
```

ENTER ↓

```

RELAY 1 SETPOINT
                    ##### gal
    
```

ENTER ↓

```

RELAY 1 HYSTERESIS
                    ##### gal/m
    
```

ENTER ↓

Advance To
SETUP RELAYS 3, 4

Select the desired Relay for setup.
(Relays 3 & 4 Optional, menus will always appear even if option not installed)

If Relay 1 or Relay 2 Selected,
Select Rate, Total or NA.

If Rate selected, enter desired relay activation delay value. Alarm condition must be continuously present for this amount of time before alarm will activate.

If Total Selected, Enter desired Relay Duration.

Select the desired Relay Activation.
Low: Relay activates when reading is below setpoint.
High: Relay activates when reading is above setpoint.

Enter the desired Setpoint. The Setpoint can be edited in run mode using the PRE 1 key (PRE 2 key for Relay 2).

If Rate, selected, Enter desired Relay Hysteresis.

Sub-menus	Display	Notes
<p>6.4.9 (Continued) SETUP RELAYS (Relay 3 & Relay 4)</p>	<pre> SETUP RELAYS R1y1 R1y2 R1y3 R1y4 ENTER ↓ RELAY 3 USAGE Rate Tot Alrm Ovr NA RELAY 4 USAGE Rate Tot Alrm NA ENTER ↓ RELAY 3 DELAY sec 0 ENTER ↓ RELAY 3 DURATION ##### ENTER ↓ RELAY 3 MODE LO_ALARM HI_ALARM ENTER ↓ RELAY 3 SETPOINT ##### gal ENTER ↓ RELAY 3 HYSTERESIS ##### gal/m ENTER ↓ Advance To SETUP CONTROL INPUTS </pre>	<p>Select the desired Relay for setup. (Relays 3 & 4 Optional)</p> <p>If Instrument Type is set for BATCHER, Choose Rate, Total, Alrm, Ovr or NA.</p> <p>If Instrument Type is set for RATE/TOTAL, Choose Rate, Total, Alrm or NA.</p> <p>If Rate / Alrm selected, enter desired relay activation delay value.</p> <p>If Total Selected, Enter desired Relay Duration.</p> <p>Select the Relay Activation for Rate/Alrm. Low: Relay activates when reading is below setpoint. High: Relay activates when reading is above setpoint.</p> <p>Enter the desired Setpoint. The setpoint 3 can be edited in the "Run Mode" using the 4 key (9 key for Relay 4).</p> <p>If Rate, selected, Enter desired Relay Hysteresis.</p>

NOTE:
 Settings for Relays 3 & 4 may be entered even if relays are not supplied. The settings will still trigger display alarm messages if applicable.

RELAY NOTES & CONSIDERATIONS

1. Relay activation is based on the computed readings not the displayed value. Therefore the display damping factor will not affect the relay response time. The RELAY DELAY feature allows the user to enter a time delay for relay activation. This feature is very useful in applications where short over/under range conditions are not considered alarm conditions.
2. When INSTRUMENT TYPE is set to batcher, Relay 1 is reserved for PRESET and Relay 2 is reserved for PREWARN or NA (not assigned).
3. Setting the relays to NA (Not Assigned), will allow the relay activation to be controlled via the RS-232 Serial and/or RS-485 Modbus ports. It also allows the Presets to be used for other numeric entry values via serial commands which can be part of the print list.
4. Relay 3 and Relay 4 settings may be used to trigger display alarm conditions even if the relays are not supplied.

Sub-menus	Display	Notes
6.4.10 SETUP CONTROL INPUTS (RATE/TOTAL)	<pre> SETUP CONTROL INPUTS [ENTER] SETUP CONTROL INPUTS Input1 Input2 Input3 [ENTER] CONTROL INPUT1 USAGE INHIBIT_TOTAL NA CONTROL INPUT2 USAGE RESET_TOTAL NA CONTROL INPUT3 USAGE Prn Ack KeyLk NA [ENTER] Advance To SETUP REALTIME CLOCK </pre>	<p>Press Enter to begin setup of the Control Inputs.</p> <p>Select the desired Control Input for setup.</p> <p>If Control Input 1 Selected, Select Inhibit Total or NA (Not Assigned).</p> <p>If Control Input 2 Selected, Select Reset Total or NA (Not Assigned).</p> <p>If Control Input 3 Selected, Select Prn (Print), Ack (acknowledge), KeyLk (Keylock) or NA (Not Assigned). ACK will acknowledge and clear alarms and warning messages. Note: Alarms may reassert themselves if alarm conditions are still present.</p>
6.4.11 SETUP CONTROL INPUTS (BATCH)	<pre> SETUP CONTROL INPUTS Input1 Input2 Input3 [ENTER] CONTROL INPUT1 USAGE Start Rst/Start NA CONTROL INPUT2 USAGE Stop Stop/Rst NA CONTROL INPUT3 USAGE Rst Prn KeyLk Ack NA [ENTER] Advance To SETUP REALTIME CLOCK </pre>	<p>Select the desired Control Input for setup.</p> <p>If Control Input 1 Selected, Select Start ,Reset/Start, NA (Not Assigned).</p> <p>If Control Input 2 Selected, Select Stop, Stop/Reset, NA (Not Assigned).</p> <p>If Control Input 3 Selected, Select Prn (Print), Ack (acknowledge), KeyLk (Keylock) or NA (Not Assigned). ACK will acknowledge and clear alarms and warning messages. Note: Alarms may reassert themselves if alarm conditions are still present.</p>

Sub-menus	Display	Notes
6.4.12 SETUP REALTIME CLOCK (Time)	<pre> SETUP REALTIME CLOCK [ENTER] ↓ SETUP REALTIME CLOCK Time Date [ENTER] ↓ CLOCK TYPE 24HR 12HR [ENTER] ↓ SELECT CLOCK AM/PM AM PM [ENTER] ↓ TIME OF DAY HH:MM:SS ##:##:## [ENTER] ↓ Advance To SETUP REALTIME CLOCK (Date) </pre>	<p>Press Enter to begin setup of the Realtime Clock.</p> <p>Select Time to set the time.</p> <p>Select 24Hr or 12Hr clock</p> <p>If 12Hr Clock, Enter AM or PM</p> <p>Enter time of day.</p>
6.4.13 SETUP REALTIME CLOCK (Date)	<pre> SETUP REALTIME CLOCK Time Date [ENTER] ↓ DATE: MONTH, DAY, YEAR ##/##/#### [ENTER] ↓ Advance To SERIAL USAGE </pre>	<p>Select Date to enter the date.</p> <p>Enter the date. (Month, Day, Last two digits of Year, first two digits of year will adjust accordingly)</p>

Sub-menus

Display

Notes

**6.4.14
SERIAL USAGE**

```
SERIAL USAGE
```

Press Enter to begin setup of the Serial Port.

ENTER ↓

```
SERIAL HARDWARE
RS232      RS485
```

Select Serial Hardware type for standard port. RS-232 is standard. (See SETUP NETWORK CARD for RS485 Modbus option)

ENTER ↓

```
DEVICE ID
                                     ##
```

Select the Device ID (0-99).

ENTER ↓

```
BAUD RATE
300  600 1200 <more>
```

Select the desired Baud Rate.

```
BAUD RATE
2400 4800 9600 19200
```

(If <more> selected, additional baud rates are offered. 9600 is standard)

ENTER ↓

```
PARITY
None  Odd  Even
```

Select the desired Parity. (NONE is standard)

ENTER ↓

```
HANDSHAKING
None Software Hardware
```

Set the Handshake. (NONE is standard)

ENTER ↓

```
DEVICE LINE FEED
<CR>          <CR+LF>
```

Choose end of line termination. Only choose <CR> if your external device automatically assigns a line feed for every <CR> carriage return.

ENTER ↓

```
MODEM CONTROL
No          Yes
```

Select "Yes" if the serial port will be used to control a Hayes compatible modem.

ENTER ↓

```
MODEM AUTO ANSWER
No          Yes
```

Select the desired Modem Auto Answer mode. Select YES to setup modem to answer incoming calls.

ENTER ↓

```
CALL OUT PHONE #
                                     0
```

Enter the Call Out Phone Number to be dialed at "Call Out Time" or upon "Call On Error/Alarm".

ENTER ↓

```
CALL OUT TIME
                                     ##:##:##
```

Enter the time of day to perform Call Out transmission.

ENTER ↓

```
CALL ON ERROR/ALARM
No          Yes
```

Select "Yes" to have the unit perform a Call Out transmission upon error/alarm condition.

ENTER ↓

```
NUMBER OF REDIALS
                                     0
```

Enter the number of redials to be performed on call out time if busy or no answer. (error/alarm tries until connected)

ENTER ↓

```
HANGUP IF 2MIN INACT
No          Yes
```

Select "Yes" to perform hang-up if there is inactivity for more than 2 minutes for calls initiated by the 926-ST1LE.

ENTER ↓

Advance To
SETUP DATALOG/PRINT

Sub-menus	Display	Notes
6.4.15 SETUP DATALOG/PRINT (Configure)	<pre>SETUP DATALOG/PRINT</pre>	Press Enter to setup the Datalog/Print information.
	<pre>ENTER ↓ SETUP DATALOG/PRINT Config Select_list</pre>	Select Config to configure the Datalog/Print information.
	<pre>ENTER ↓ OUTPUT FORMAT Printer Term Dbase</pre>	Select the type of Output Format.
	<pre>ENTER ↓ PAGE LENGTH [99 max] 99</pre>	Enter the desired Page Length. If Printer selected above.
	<pre>ENTER ↓ TOP MARGIN [99 max] 3</pre>	Enter the desired Top Margin. If Printer selected above.
	<pre>ENTER ↓ DATALOG ONLY No Yes</pre>	Select Yes to record events to the datalogger only. Events will not be sent to the serial port. Select NO to output immediately and also log data.
	<pre>ENTER ↓ PRINT TIME HH:MM:SS 00:00:00</pre>	Enter Print Time, printer will print at this time every day. Enter 00:00:00 to inhibit print time.
	<pre>ENTER ↓ PRINT INTERVAL 00:00:00</pre>	Enter Print Interval, (HH:MM:SS) Enter 00:00:00 to inhibit print interval.
	<pre>ENTER ↓ ENABLE PRINT KEY NO YES</pre>	Select YES to enable Print Key. Select NO to disable Print Key.
	<pre>ENTER ↓ PRINT END OF BATCH NO YES</pre>	Batch mode only. Select Yes to print at end of batch.
	<pre>ENTER ↓ Advance To SETUP DATALOG/PRINT (Select_list)</pre>	

Sub-menus

Display

Notes

**6.4.16
SETUP
DATALOG/PRINT**
(Select_list)

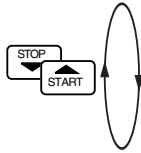

List Items:

- TOTAL
- RATE
- PRE1
- PRE3
- GRAND
- PRE2
- PRE4
- TIME

```

SET DATALOG/PRINT
[ENTER]
SET DATALOG/PRINT
Config Select_list
PRINT LIST ITEMS
TOTAL YES
PRINT LIST ITEMS
RATE YES
PRINT LIST ITEMS
PRE 1 YES
[ENTER]
PRINT LIST ITEMS
DataLog size =001489
[ENTER]
Advance To
ADMINISTRATIVE SETUP
    
```

Press enter to begin Setup Datalog/Print routine.

Press enter when Select_list is selected to setup print list.

Use Up and Down arrow keys to view list status. Press the PRINT key to add or remove items from the list. Items marked with Yes will be added to the list, items marked with No will be removed from the list. Press ENTER to accept list when ready

The Select Print List Information display shows the current possible Datalog size after your list has been entered.

**6.4.17
ADMINISTRATIVE
SETUP**

NOTE: Accessed only with supervisor password.

```

ADMINISTRATIVE SETUP
[ENTER]
OPERATOR PASSWORD *****
[ENTER]
SUPERVISOR PASSWORD *****
[ENTER]
SOFTWARE VERSION vxx.xx
[ENTER]
PRODUCT ORDER CODE SL90xxxxxxxx
[ENTER]
UNIT SERIAL NUMBER 00000
[ENTER]
SENSOR SERIAL NUMBER 00000
[ENTER]
Advance To
SETUP NETWORK CARD
    
```

Press Enter to begin Administrative Setup.

Enter Operator Password. (Factory Set to 0) Define a nonzero value for each unit to lock unit and prevent accidental menu changes.

Enter Supervisor Password. (Factory Set to 2000)

This display is used to show the software version of the installed software.

This display is used to show the product order code (model number). Factory set.

This display is used to show the unit's serial number. Factory set.

This display is used to edit and show the sensor's serial number.

7. Principals Of Operation

7.1 General:

The 926-ST1LE Flow Computer uses several internal calculations to compute the input frequency based on specific data input. Several computations are performed to yield flow or linearized flow.

7.2 Flow Equations:

Uncompensated Flow Computation:

Pulse Input; Average K-Factor

$$\text{Volume Flow} = \frac{\text{input frequency} \cdot \text{time scale factor}}{\text{K-Factor}}$$

Pulse Input; Linear Table

$$\text{Volume Flow} = \frac{\text{input frequency} \cdot \text{time scale factor}}{\text{K-Factor (Hz)}}$$

Where K-Factor (Hz) is the K-Factor returned at frequency (Hz) from interpolation of the 16 point table.

7.3 Linearization Table

7.3.1 Linearization Table General Information

The Linearization Table is used when the flow input device gives a nonlinear input signal. The unit uses up to 16 different points, as entered by the operator, to form a curve for linearizing the input signal.

Notes:

- 1) A minimum of three points must be set up.
- 2) If "0" is entered for the frequency of any point other than point 1, the Flow Computer assumes there are no more points above the points that preceded them. The display will advance to the next setup prompt.
- 3) If the input frequency is above the highest or below the lowest frequency programmed, the unit will use the last known point for the K factor in computing the resulting actual flow.
- 4) Frequency- Point pairs should be entered in ascending order of frequency.

7.3.2 Linearization Table for Pulse Inputs

The linearization table for pulse inputs programming is quite simple when values of frequency and K-Factors are known. The Flow Computer asks for 16 different frequencies (Freq) and 16 corresponding K factors (K). It then uses this data to determine what the actual flow is for any given input frequency. Usually the necessary data is provided with the flowmeter.

7.3.3 Linearization Table Interpolation

The Linearization Table routine uses the entered data to determine the K factor for any given input frequency signal. This is done by taking the closest data points above and below the input signal, then using those points to interpolate the K factor (correction factor), then calculating the flow from the data. Below are the formulas.

Parameters:

Determine closest point above input signal
 signal = X, K factor (correction factor) = KA

Determine closest point below input signal
 signal = Y, K factor (correction factor) = KB

Let input signal = H,
 unknown K factor (correction factor) = KN

To find KN use this formula:

$$\frac{H - Y}{X - Y} \times (KA - KB) + KB = KN$$

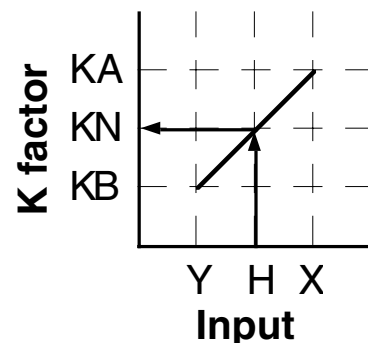

8. Test, Service and Maintenance

8.1 Test Menus

Sub-menus	Display	Notes
8.1.1 TOP LEVEL TEST MENUS	<pre> SELECT OPERATE STATE Run Setup Test </pre> <p>↑ MENU ENTER ↓</p>	<p>Select Test to enter the instrument test & calibration routine. NOTE: Supervisor (Service) password required to gain access to this mode.</p>
	<pre> Audit Trail </pre> <p>STOP ↓ ↑ START</p>	<p>Refer to Page 36 for Details.</p>
	<pre> Error history </pre> <p>STOP ↓ ↑ START</p>	<p>Refer to Page 36 for Details.</p>
	<pre> Print System Setup </pre> <p>STOP ↓ ↑ START</p>	<p>Refer to Page 36 for Details.</p>
	<pre> Keypad Test </pre> <p>STOP ↓ ↑ START</p>	<p>Refer to Page 37 Details.</p>
	<pre> Display test </pre> <p>STOP ↓ ↑ START</p>	<p>Refer to Page 37 for Details.</p>
	<pre> Calibrate </pre> <p>STOP ↓ ↑ START</p>	<p>Refer to Page 37 Details.</p>
	<pre> Pulse input test </pre> <p>STOP ↓ ↑ START</p>	<p>Refer to Page 38 Details.</p>
	<pre> Analog out test </pre> <p>STOP ↓ ↑ START</p>	<p>Refer to Page 38 for Details.</p>
	<pre> Excitation out test </pre> <p>STOP ↓ ↑ START</p>	<p>Refer to Page 38 for Details.</p>
	<pre> Pulse out test </pre> <p>STOP ↓ ↑ START</p>	<p>Refer to Page 39 for Details.</p>
	<pre> Relay Test </pre> <p>STOP ↓ ↑ START</p>	<p>Refer to Page 39 for Details.</p>
	<pre> Control inputs test </pre> <p>STOP ↓ ↑ START</p>	<p>Refer to Page 39 for Details.</p>
	<pre> Data logger utility </pre> <p>STOP ↓ ↑ START</p>	<p>Refer to Page 39 for Details.</p>



8.2 Test Sub-Menus

Sub-menus	Display	Notes
8.2.1 Audit Trail Sub-menu Group	<pre>Audit Trail</pre>	Press Enter to view the audit trail information.
	<pre>Config_Audit nnnnn hh:mm:ss mm/dd/yy</pre>	The configuration audit trail format: nnnnn= number of critical menu changes, hh:mm:ss; mm/dd/yy = time and date of last change.
	<pre>Cal_Audit nnnnn hh:mm:ss mm/dd/yy</pre>	The calibration audit trail format: nnnnn= number of calibration changes, hh:mm:ss; mm/dd/yy = time and date of last change.
	<pre>Audit Trail</pre>	Press Menu to get back to audit trail top-level menu.
8.2.2 Error History Sub-menu Group	<pre>Error history</pre>	Press Enter to view error history. NOTE: Press Print Key to print Error History. Printout will include time/date of each errors first occurrence.
	<pre>Error history Flow rate alarm low</pre>	Press Up/Down arrow keys to scroll through error message history. Press CLEAR to clear entire error log.
	<pre>Error history</pre>	Press Menu to get back to error history top-level menu.
8.2.3 Print System Setup Sub-menu Group	<pre>Print System Setup</pre>	Press enter key to enter print system setup Sub-menu.
	<pre>Print System Setup Press ENTER to print</pre>	Press enter to begin printing the system setup.
	<pre>Print System Setup -- Printing ---</pre>	This message will display as the data transmission takes place.
	<pre>Print System Setup</pre>	Press Menu to get back to print system setup top-level menu.

<u>Sub-menus</u>	<u>Display</u>	<u>Notes</u>
<p>8.2.4 Keypad test Sub-menu Group</p>	<pre>Keypad test ENTER ↓ Keypad test Key pressed-> ENTER ENTER ↓ Keypad test</pre>	<p>Press Enter to enter keypad test.</p> <p>Press the various keys and the display will show the key that was pressed. Press Menu to exit the test.</p> <p>Press Menu to get back to Keypad test top-level menu.</p>
<p>8.2.5 Display test Sub-menu Group</p>	<pre>Display test ENTER ↓ 000000000000000000000000 000000000000000000000000 ENTER ↓ Display test</pre>	<p>Press Enter to enter display test.</p> <p>Upon pressing enter the each digit on the display will scroll 0-9 then A-Z. Press menu to exit the test.</p> <p>Press Menu to get back to Display test top-level menu.</p>
<p>8.2.6 Calibrate 0 mA Out Sub-menu Group</p>	<pre>Calibrate ENTER ↓ Calibrate 0mA out + TB1-15 - TB1-16 ENTER ↓ Calibrate 0mA out Enter mA: 0.00000 ENTER ↓ Calibrate 0mA out + TB1-15 - TB1-16 ENTER ↓</pre>	<p>Calibrate Sub-menu group.</p> <p>Connect ammeter to (+) TB1-15, (-) TB1-16. Press enter.</p> <p>To trim 0mA output: Press CLEAR to enable editing and enter a small negative number (i.e. -0.100) to force a display reading, then clear and enter small quantity measured on your meter.</p> <p>The display will return to Calibrate 0mA out. Press the down arrow key to advance to Cal. 20mA out or repeat above if necessary.</p>
<p>8.2.7 Calibrate 20mA Out Sub-menu Group</p>	<pre>Calibrate 20mA out + TB1-15 - TB1-16 ENTER ↓ Calibrate 20mA out Enter mA: 20.00000 ENTER ↓ Calibrate 20mA out + TB1-15 - TB1-16 ENTER ↓ Calibrate</pre>	<p>Connect ammeter to (+) TB1-15, (-) TB1-16. Press enter.</p> <p>To trim 20mA output: Press CLEAR to enable editing and enter the current reading that is on the ammeter display. Press enter.</p> <p>The display will automatically return to the Calibrate 20mA out Sub-menu. Calibration is complete.</p> <p>Press the Menu key to go back to Calibrate top-level menu.</p>

Sub-menus	Display	Notes
8.2.8 Pulse input test Sub-menu Group	<pre> Pulse input test ENTER ↓ Pulse input test Trigger level 2.5V START ↑ STOP ↓ ENTER ↓ Pulse input test count speed 3kHz START ↑ STOP ↓ ENTER ↓ Pulse input test F1: 0 F2: 0 ENTER ↓ Pulse input test </pre>	<p>Press Enter key to test the pulse input.</p> <p>Use the Up/Down arrow keys to select the appropriate trigger level.</p> <p>Use the Up/Down arrow keys to select the appropriate frequency range.</p> <p>To check Pulse input accuracy: Use TB1-4 as reference ground, input a frequency F1 on TB1-2, frequency F2 on TB1-3. The display should show frequency being input. Use a frequency counter to verify input.</p> <p>Press Menu key to return to Pulse input test top-level menu.</p>
8.2.9 Analog out test Sub-menu Group	<pre> Analog out test ENTER ↓ Analog out test *0 4 10 15 20 mA ENTER ↓ Analog out test </pre>	<p>Press Enter to test the analog output.</p> <p>To simulate analog output: Connect an ammeter to (+) TB1-15, (-) TB1-16. Press the key under the desired current setting to move the asterisk (*). The unit should output the selected current.</p> <p>Press Menu key to return to Analog out test top-level menu.</p>
8.2.10 Excitation out test Sub-menu Group	<pre> Excitation out test ENTER ↓ Excitation out test *5v 12v 24v ENTER ↓ Excitation out test </pre>	<p>Press Enter to test the excitation output.</p> <p>To test the excitation output: Connect a voltmeter to (+) TB1-1, (-) TB1-4. Press the key under the desired voltage setting to move the asterisk (*). The unit should output the selected voltage.</p> <p>Press Menu key to return to Excitation out test top-level menu.</p>

**8.2.11
Pulse out test
Sub-menu Group**

```
Pulse out test
ENTER ↓
Pulse out test
*0Hz 1Hz 10Hz 20Hz
ENTER ↓
Pulse out test
```

Press Enter key to test the pulse output.

To simulate a frequency on the pulse output: Connect a frequency counter to (+)TB1-13, (-)TB1-14. Press the key under the desired frequency setting to move the asterisk (*). The unit should output the selected frequency.

Press Menu key to return to Pulse out test top-level menu.

**8.2.12
Relay test
Sub-menu Group**

```
Relay Test
ENTER ↓
Rly1 Rly2 Rly3 Rly4
Off Off Off Off
ENTER ↓
Relay Test
```

Press Enter to test the relays.

To manually control the relay outputs: Press the key under the desired relay to toggle the relays On/Off. Use an ohmmeter to check the relay contacts.

Press Menu key to return to Relay Test top-level menu.

**8.2.13
Control inputs test
Sub-menu Group**

```
Control inputs test
ENTER ↓
TB1-9 TB1-10 TB1-11
Off Off Off
ENTER ↓
Control inputs test
```

Press Enter to test the control inputs.

To check the control inputs: Use TB1-12 as reference, input a DC voltage (4-24VDC) signal to TB1-9, TB1-10 and/or TB1-11, The Display will show ON when input is active, OFF when inactive.

Press Menu key to return to control input test top-level menu.

**8.2.14
Data logger utility
Sub-menu Group**

```
Data logger utility
ENTER ↓
Data logger utility
Log 10 958 Max
ENTER ↓
Data logger utility
Log 00001 PRT CLR
ENTER ↓
Data logger utility
```

Press Enter to access data logger utility.

The displays shows the number of Data Logs. Press the Down arrow key to advance to PRT (print) or CLR (clear) to clear datalog contents.

Press PRINT key to output data logger logs to printer. Press CLEAR key to clear the data logger contents.

Press Menu key to return to Data logger utility top-level menu.

8.3 Internal Fuse Replacement

Instructions:

1. Make sure you follow proper E.S.D. Precautions. All persons performing this replacement must follow proper grounding procedures.
2. Turn the power to the unit off.
3. Disconnect the two piece connector rear terminal block, leaving all connections in place.
4. Remove the unit from the panel.
5. Remove the four machine screws (see fig. 1) which hold the two sections of the case together.
6. The rear section of the case should detach from the rest of the case. With the rear section of the case removed the fuse will be exposed (located near the rear terminal, AC connection).
7. Locate the Fuse F1 (see fig. 2) and unplug the fuse from its socket.
8. Insert the new fuse into the socket. Insure that the pins are fully inserted and straight.
9. Reassemble the case and install the four machine screws which join the two sections of the case.
10. Reinstall the unit into the panel.
11. Reconnect the rear terminal block.
12. Turn the unit back on.

Fuse Specifications:

110 VAC Power: 160mA/250V, TD Wickman 19372-030-k or equivalent
 220 VAC Power: 80mA/250V, TD Wickman 19372-026-k or equivalent
 12/24 VDC Power: 800mA/250V, TD Wickman 19374-046-k or equivalent

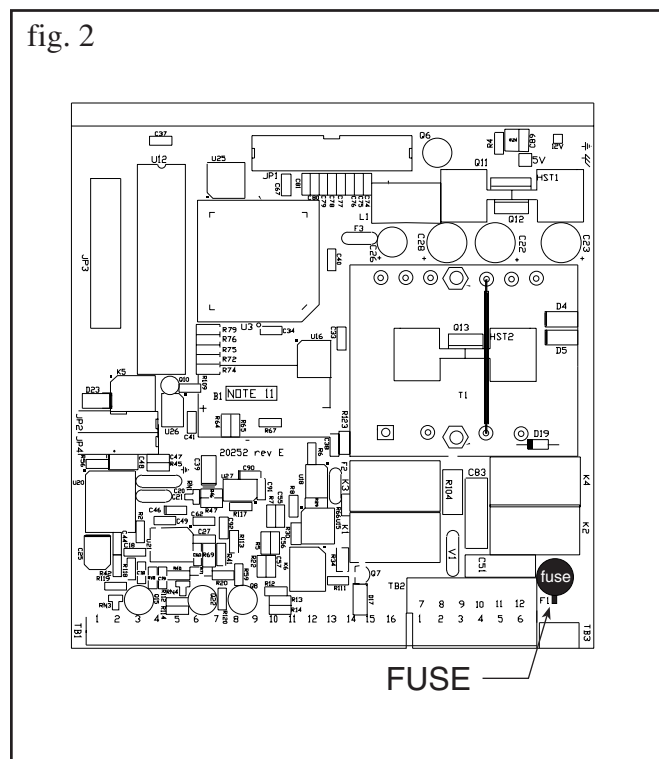
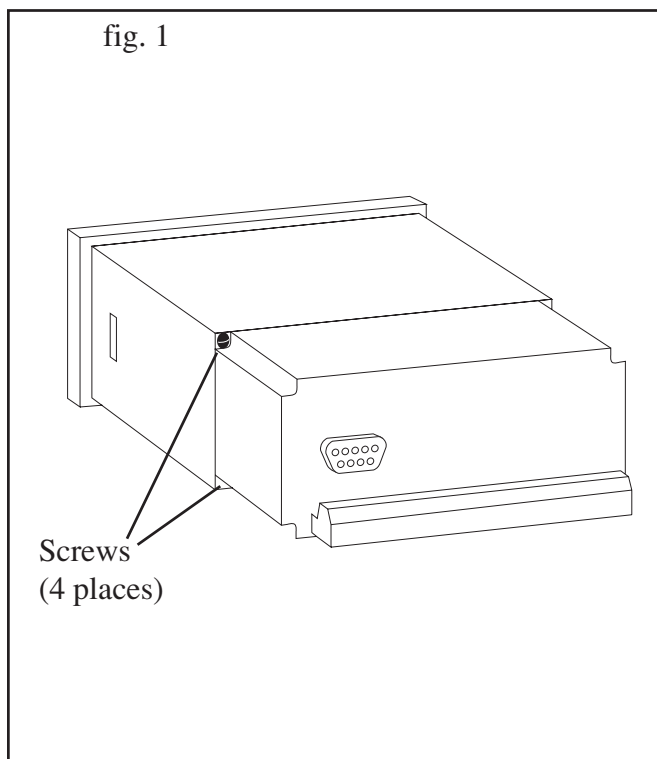

9. RS-232 Serial Port

9.1 RS-232 Port Description:

The 926-ST1LE has a general purpose RS-232 Port which may be used for any one of the following purposes:

- Transaction Printing
- Data Logging
- Remote Metering by Modem (optional)
- Computer Communication Link
- Configuration by Computer
- Print System Setup
- Print Calibration/Malfunction History

9.2 Instrument Setup by PC's over Serial Port

A Diskette program is provided with the 926-ST1LE that enables the user to rapidly configure the 926-ST1LE using a Personal Computer. Included on the diskette are common instrument applications which may be used as a starting point for your application. This permits the user to have an excellent starting point and helps speed the user through the instrument setup.

9.3 Operation of Serial Communication Port with Printers

926-ST1LE's RS-232 channel supports a number of operating modes. One of these modes is intended to support operation with a printer in metering applications requiring transaction printing, data logging and/or printing of calibration and maintenance reports.

For transaction printing, the user defines the items to be included in the printed document. The user can also select what initiates the transaction print generated as part of the setup of the instrument. The transaction document may be initiated via a front panel key depression, a remote contact closure, or upon completion of a batch.

In data logging, the user defines the items to be included in each data log as a print list. The user can also select when or how often he wishes a data log to be made. This is done during the setup of the instrument as either a time of day or as a time interval between logging.

The system setup and maintenance report list all the instrument setup parameters and usage for the current instrument configuration. In addition, the Audit trail information is presented as well as a status report listing any observed malfunctions which have not been corrected.

The user initiates the printing of this report at a designated point in the menu by pressing the print key on the front panel.

9.4 926-ST1LE RS-232 Port Pinout

- 1 Handshake Line
- 2 Transmit
- 3 Receive
- 4 Do Not Use
- 5 Ground
- 6 Do Not Use
- 7 Do Not Use
- 8 Do Not Use
- 9 Do Not Use

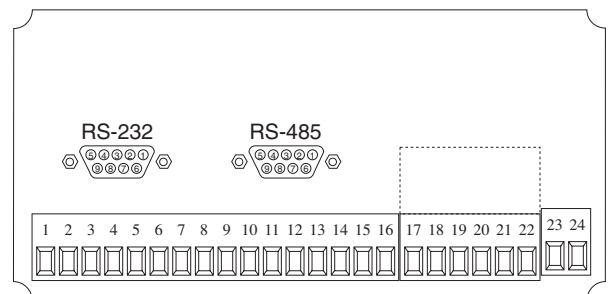
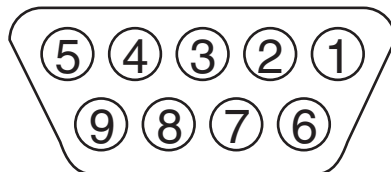

10. RS-485 Serial Port (optional)

10.1 RS-485 Port Description:

The 926-ST1LE has a an optional general purpose RS-485 Port which may be used for any one of the following purposes:

Accessing Process Parameters

Rate, Temperatures, Density, Setpoints, Month, Day, Year, Hour, Minutes, Seconds, etc.

Accessing System Alarms

System, Process, Self Test, Service Test Errors

Accessing Totalizers

Totalizer and Grand Totalizer

Executing Various Action Routines

Reset Alarms, Reset Totalizers, Print Transaction, Reset Error History, Start, Stop, Clear

10.2 General

The optional RS-485 card utilizes Modbus RTU protocol to access a variety of process parameters and totalizers. In addition, action routines can be executed. For further information, contact factory and request RS-485 Protocol manual for 926-ST1LE.

10.3 Operation of Serial Communication Port with PC

The flow computer's RS-485 channel supports a number of Modbus RTU commands. Refer to port pinout (below) for wiring details. Modbus RTU drivers are available from third party sources for a variety of Man Machine Interface software for IBM compatible PC's.

The user reads and writes information from/to the RS-485 using the Modbus RTU commands. The 926-ST1LE then responds to these information and command requests.

Process variables and totalizers are read in register pairs in floating point format. Time and date are read as a series of integer register values. Alarms are individually read as coils. Action routines are initiated by writing to coils.

10.4 926-ST1LE RS-485 Port Pinout

- 1 Ground
- 2 Ground
- 3 Ground
- 4 TX/RX (+)
- 5 TX/RX (-)
- 6 Do Not Use
- 7 Terminating Resistor (180 Ω)
- 8 TX/RX (+)
- 9 TX/RX (-)

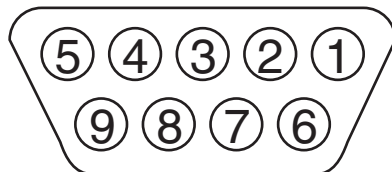

Connect terminal 7 to either terminal 4 or 8 to provide required cable termination

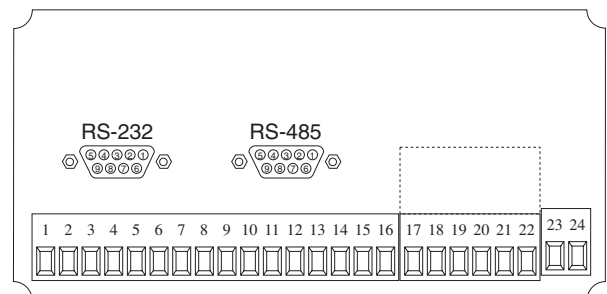

11. Flow Computer Setup Software

The 926-ST1LE setup program provides for configuring, monitoring and controlling a 926-ST1LE unit.

Sample applications are stored in disk files. The setup program calls these *Templates*. You can store the setup from the program's memory to either the 926-ST1LE (*Downloading* the file) or to a disk file (*Saving* the file) for later usage. Similarly you can load the setup in program memory from either a disk file (*Opening* a file) or from the 926-ST1LE unit (*Uploading* a file).

The program can monitor outputs from the unit while it is running.

The program can reset alarms and totalizers.

For assistance there are mini-helps at the bottom of each screen in the program. There is also context sensitive help available for each screen accessible by pressing the F1 key.

11.1 System Requirements:

IBM PC or compatible with 386 or higher class microprocessor

4 MB RAM

3 MB free disk space

VGA or higher color monitor at 640 x 480

Microsoft® Windows™ 3.1 or 3.11 or Windows 95/98™ or higher

Communication Port - RS-232

RS-232 Cable

11.2 Cable and Wiring Requirements:

The serial communication port on your PC is either a 25 pin or 9 pin connector. No cabling is supplied with the setup software. A cable must be purchased separately or made by the user. It is recommended to purchase a modem cable which matches the available communication port on you PC and a 9 pin male connection for the 926-ST1LE serial port.

11.3 Installation for Windows™

The Setup Software includes an installation program which copies the software to your hard drive.

Insert Setup Disk 1 in a floppy drive.

In the Program Manager, click File, and then select Run.

NOTE: For Windows 95™ Click the Start button, select Run and proceed as follows:

Type the floppy drive letter followed by a colon (:), and a backslash (\), and the word setup. For Example:

a:\setup

Follow the instructions on your screen.

11.4 Using the Flow Computer Setup Software

The setup software window consists of several menu "Tabs". Each tab is organized into groups containing various configuration and/or monitoring functions. To view the tab windows, simply click on the tab. The previous tab window will be hidden as the new tab window is brought to the foreground.

11.5 File Tab

The File Tab has three sections. Any of the options on this tab can also be accessed from the File Sub-menu.

The **Template Section** provides for opening and saving templates. The *Save* and *Save As* buttons provide the standard Windows functionality for dealing with files. The *Open* button is used to open existing templates.

There are two additional menu items available *only* from the File pulldown menu: *Open Existing File* and *Open Template*.

The *Open Existing File* option allows for creating custom templates using the existing template in memory as the starting point.

The *Open Template* option will bring up a list of predefined templates that can be loaded into the program. These predefined templates are useful as a starting point when defining custom templates.

A typical scenario using the setup program would be the following:

- Open up a predefined template from the supplied list
- Choose 'Save As' to save this to a new file name
- Proceed to customize the template by making any changes that are needed
- Save the template to disk (if you want to reuse this template)
- Download the template to an attached unit.

The **Communications with Flow Computer Section** allows the user to upload a template file from the unit or download the program's current template to the unit.

The **Print (report) Section** allows the user to:

1. Configure the current Windows printer through the *Select Printer* option.
2. Print a Maintenance Report through the PC's printer using the *Print Maintenance* option.
3. Print the current template through the PC's printer using *Print Setup* option.

11.6 Setup Tab

The Setup tab is where majority of the 926-ST1LE instrument setup modifications are done. The Setup tab is divided into five sections.

System Section: Instrument, Indicators

Input Section: Flow, Control Inputs

Output Section: Pulse, Currents

Relay Section: Relays

Other Settings Section: Administration, Serial Usage, Datalog/Printing, Time Clock

NOTE: Many setup items are enabled or disabled depending on previous setup selections. It is important to work your way through the above list in the order shown. Be sure to verify your selections when you are through programming to insure that no settings were changed automatically.

11.7 View Tab

The View Tab screen allows for viewing selected group items on the PC in a similar format as shown on the unit display. Data from the following groups can be viewed in the List of Values section:

Process Parameters (i.e. rate, input frequency, K-Factor, mA output)

Totalizers (i.e. total, grand total)

Version

Error Log

The setup software assumes the current setup has been uploaded from the flow computer into the PC. It is important that the setup program and the 926-ST1LE unit are using the same setup information at all times or the data will be inconsistent. It is best to upload or download the setup before using this feature.

To start the viewer, first check the boxes of items to view and then click the start button. The data will appear in the appropriate sections and will be continuously updated. The refresh rate is dependent on the number of items that are being viewed and the baud rate of the connection. Data in the List of Values section can be collapsed by clicking on the 'minus' sign in front of the group title. The data can be expanded by clicking on the 'plus' sign in front of the group title. If a group is collapsed and data in the group changes on refresh, the group will automatically expand. Changing the view items requires stopping the current viewing, checking the new selections and then restarting the viewer.

If communication errors occur while reading data from the 926-ST1LE device, the word 'Error' will appear in place of the actual value. If the connection to the 926-ST1LE is lost, the viewer will time out with a message saying the device is not responding.

The viewer will attempt to communicate with the 926-ST1LE device matching the device ID set in the communications screen. If you are having trouble establishing communication, compare settings for the PC and the flow computer. Also verify the connections between the PC and flow computer.

11.8 Misc. Tab

This tab has three sections: Tools, Actions and Options.

The tools section contains various system administration activities such as creating/modifying the initial sign-on screen and/or print header:

Create Sign-on, Create Print Header

The Actions section is used to send commands to the 926-ST1LE unit:

Reset Totalizers, Reset Alarms, Reset Alarm History

The Options section has the following selections:

Network Card Enable, Network Card Setup

12. Glossary Of Terms

Acknowledge & Clear Alarms

Acknowledge is used to clear alarm relays and remove any visual alarm messages from the display. In the run mode, press the ENTER key or activate CONTROL INPUT 3 (if set for *ACK*) to momentarily clear alarms and alarm messages. Alarms will reassert themselves if alarm conditions are still present.

Analog Output

The analog signal (4-20mA) that is generated by the 926-ST1LE. It can correspond to the Rate or Total. This output is used primarily for transmission of process information to remote systems.

Audit Trail

The audit trail is used to track the number of changes made to the units setup program and calibration.

Auto Batch Restart

The Auto Batch Restart function allows the user to set an amount of time to automatically restart a batch after the completion of a batch. This time can be set from 1 to 99 seconds.

Batch Count Mode

Batch Count Mode specifies the user preference for count direction. The "*Up*" selection begins with a value of "0" and counts up until the batch size is reached. The "*Down*" selection begins with a value equal to the desired batch size and counts down to "0".

Batch Overrun

The 926-ST1LE offers a batch overrun compensation routine. If batch overrun occurs due to slow valve response time, the unit will compensate for the overrun amount on the next batch. This feature can be disabled if desired.

NOTE: A nonzero MAX DRAIN TIME value is also required.

Batcher

An instrument which controls the dispensing of desired batch amounts. Liquid batching systems are usually comprised of a batch controller (batcher), flowmeter and control valve. The batcher opens and closes the valve through the use of relays and measures the amounts of liquid being dispensed via the flowmeter.

Baud Rate

The speed of serial communication transmissions, expressed in bits per second.

Custody Transfer

Weights and Measure metering codes often specify several requirements for instruments and mechanisms to prevent and track changes in the setup of an instrument which may be used in the commercial sale of goods. The 926-ST1LE tracks changes via the Audit Trail.

Data Logger

The capturing of information for later use and the mechanism for specifying the conditions where a capture should be made.

DC Output / Excitation Voltage

An on-board DC power supply used to power peripheral sensors. The 926-ST1LE offers excitation voltages of 5VDC, 12VDC or 24VDC when powered by AC voltage.

Default Value

The value to be used by the instrument if a sensor failure or out of range signal is detected.

EZ Setup

A utility that provides for rapid configuration of an instrument. The 926-ST1LE EZ Setup provides the following:

- 1) Prompts the user for only critical information.
- 2) Automatically sets specifications to common uses.

After following the EZ Setup procedure, the unit will be operational to perform the basic measurement. The setup can be further customized using the setup menus.

Flow Alarm

A visual indication that the volumetric flowrate is above or below the flow alarm setpoint specified by the user.

Flow Signal Timeout

The Flow Signal Timeout allows the user to enter a timeout of 0 to 99 seconds. If a batch is "Filling" and zero flow persists for more than the user entered time then the batch will be aborted. This prevents over flows due to faulty flow sensors and/or wiring.

Flow Equation

A flow control expression or algorithm describing a mathematical equation to be solved by a flow computer in the desired application.

Follow Alarm

Alarm relays which are non latching and whose output state is based solely on the comparison of the current process value, the alarm setpoint (trip point) and hysteresis.

Function Key

A key on a push-button panel or keyboard (whose function is described by the key label) used to perform an instrument function or special routine.

Handshake

A means of controlling the information flow between two pieces of equipment to prevent the sending device from transmitting information at a rate faster than what can be accepted by the receiver.

Hysteresis

The relay hysteresis is a "dead band" setting which allows the relay to remain energized for a given amount below the setpoint. This is used to prevent relay chatter when the process value is near the setpoint value.

Example: If the Preset is set at 100, and the hysteresis is set at 10, the relay will energize when the rate, temp or dens. reaches 100, the relay will remain energized until the reading falls below 90.

Input Termination

Input signal lines on digital inputs often require pullup or pulldown resistor configurations to operate properly with different sensor configurations. The 926-ST1LE contains such resistors and may be enabled via the setup menu.

Inhibit Totalizer

"*Inhibit Total*" is a Control Input 1 setting that is used to stop the totalization. If enabled, a voltage level on control input 1 will inhibit the total as long as the voltage is present. This feature is useful during meter proving and in applications that provide a sensor to signal the flow computer when liquid is present.

K-Factor

A scaling factor derived from the pulses produced by a flowmeter output, expressed in pulses per unit (i.e. pulses/gallon)

LCD

Abbreviation for: Liquid Crystal Display

Limit Setpoint

An alarm trip point setting which specifies the value or magnitude of a process parameter necessary to activate an alarm indicator or control relay.

Linear Flowmeter

A flow measurement device whose output is proportional to flow.

Linearization

The mathematical correction of a nonlinear device. The 926-ST1LE uses a linearization Table which is made up of input frequency and K-Factor values and makes interpolations of the table to arrive at a "linearized" measurement.

LinTbl

Abbreviation for Linearization Table.

Low Flow Cutoff

A value set at which any flow measurements read below this value will be ignored.

Low Pass Filter

A low pass filter passes low input frequencies while blocking high frequencies. In the 926-ST1LE, this is the maximum input count speed to be encountered in an application. It is expressed in counts per second (Hz).

Maximum Batch Preset

The Maximum Batch Preset allows the user to program the Maximum Batch value allowed to be entered by the operator. If an operator should try to program a batch higher than this value, the unit will not allow the value to be entered and will prompt the user with an error message saying that the Maximum Batch Preset has been exceeded.

Maximum Drain Time

The unit declares that a batch is “done” when the flow rate equals “0”. A flow rate may be present long after the Preset Relay de-energizes due to slow reacting valves or leaky valves. The Maximum Drain Time allows the user to enter an amount of time (0 to 99 seconds) to wait before declaring “Batch Done”. After the Preset Batch quantity is reached, the unit will declare “Batch Done” when the flow rate is “0” or the Maximum Drain Time has expired. The batch data will then be available for printing and datalogging.

NOTE: A nonzero MAX DRAIN TIME value must be entered when using batch overrun compensation.

Max Window

The max. window time sets the maximum sample time (1 to 99 sec) for the ratemeter.

Operator Code

An operator password code which authorizes changes to the setup of the instrument but blocks access to the Service/Calibration/Test mode. The operator code also blocks the clearing of the Grand Total.

Parity

A method for detecting errors in transmissions of serial communications data.

Preset

A set point used to trigger the relay outputs of the 926-ST1LE.

Print Interval

The print interval allows the 926-ST1LE to transmit information to the serial port at selectable time intervals.

Process Parameters

Any sensor information which has been scaled to engineering units including Flow, Temperature and Density.

Pulldown (Input Termination)

The termination of an input at which the input is pulled down to ground through a resistor. Inputs that are terminated by this method need to be driven high with a positive voltage pulse.

Pullup (Input Termination)

The termination of an input at which the input is pulled up to a positive voltage through a resistor. Inputs that are terminated by this method need to be pulled low with a sinking current or contact to ground .

Pulse Output

The pulse output of the 926-ST1LE is available for remote accumulation of the total or sent to peripheral devices, such as a PLC. The output can be scaled using the Pulse Output Scaling Constant.

Quad

Abbreviation for Quadrature. Quadrature signals are used for direction control. Two flowmeter signals are output with a 90° phase shift. The counter counts UP when channel A precedes channel B, and counts DOWN when Channel A lags Channel B.

Quick Update %

This feature is used to disable the rate averaging filter when a significant change in the flow rate occurs. The user

can enter the percent of change needed to be detected to disable the averaging feature. This is especially useful during start-up and shutdown of flow.

Rate Averaging Filter

The rate averaging filter is used to stabilize fluctuating rate displays. Higher settings provide more averaging for a more stable display. Derived from the equation:
$$\frac{((\text{OLD DATA} \times \text{"Avg. Filter"}) + \text{NEW DATA})}{(\text{"Avg. Filter"} + 1)}$$

Ratometer

Any device used to display the speed of a process. The ratemeter in the 926-ST1LE displays flow rate.

Reset/Start Control Input

In a batching system, a single operator activation of the START key or Control Input 1 will reset the total then start the batch process.

Select Preset Type

This menu selection allows the user to choose between Standard Preset or EZ Preset. Select Standard for standard preset operation. Select EZ-Preset for quick preset editing mode. (see section 5.4.1 Batch Configuration.)

Single_Pulse

The Single_Pulse setting is used for flowmeters with single pulse outputs.

Slow Start Quantity

The Slow Start Quantity is a function that allows an amount to be entered for a Slow Start up. This function requires two stage valve control. RLY 1 (slow flow) will energize for Slow Start and RLY 2 (fast flow) will energize after the Slow Start Quantity has been delivered. This helps reduce turbulence when filling an empty container.

Stop/Reset Control Input

In a batching system, a single operator activation of the STOP key or Control Input 2 will stop the batch process then reset the total.

Totalizer

Any device which accumulates and displays a total count.

Volume Flow

The measurement of volumetric flow.

13. Diagnosis and Troubleshooting

13.1 Response of 926-ST1LE on Error or Alarm:

Error and warning indications which occur during operation are indicated in the RUN mode alternately with the measured values. The 926-ST1LE Flow Computer has three types of error:

TYPE OF ERROR	DESCRIPTION
Sensor/Process Alarms	Errors detected due to sensor failure or process alarm conditions
Self Test Errors	Errors detected during self test.
System Alarms	Errors detected due to system failure

Some alarms are self clearing. Other alarms require the user to acknowledge and clear the alarm. Press the ENTER button to acknowledge and clear alarms. Alarms may reassert themselves if the alarm condition is still present.

NOTE: A historical error alarm log is available in the "Test Mode".

The following descriptions suggest possible causes and corrective actions for each alarm message.

13.2 Diagnosis Flow Chart and Troubleshooting

All instruments undergo various stages of quality control during production. The last of these stages is a complete calibration carried out on state-of-the-art calibration rigs.

A summary of possible causes is given below to help you identify faults.

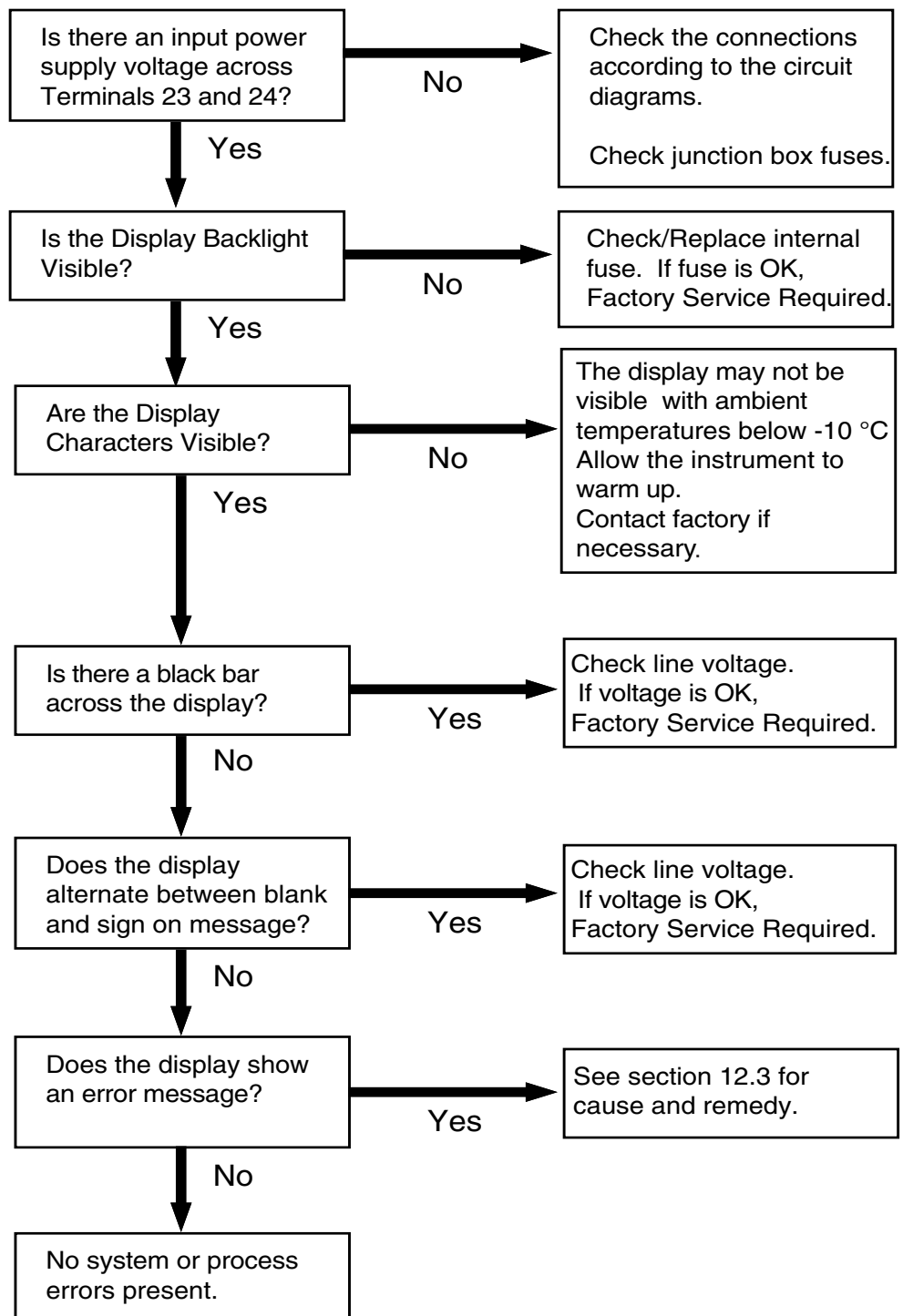

13.3 Error & Warning Messages:

13.3.1 Sensor/Process Alarms

Error/Warning Message	Cause	Remedy
TOTALIZER ROLLOVER	Displayed when totalizer rolls over	<ul style="list-style-type: none"> • Acknowledge Rollover • Remedy not required
RATE OVERFLOW ERROR	Pulse counter overflowed. The totalizer may have lost counts.	<ul style="list-style-type: none"> • Report error to factory • Check application conditions • Check wiring
PULSE OUT OVERFLOW	Calculated pulse frequency too large: <ul style="list-style-type: none"> • Pulse width setting too long • Larger pulse scaler needed 	<ul style="list-style-type: none"> • Adjust pulse value • Adjust pulse width • Check process conditions
FLOW RATE ALARM LOW FLOW RATE ALARM HIGH	Limit value exceeded.	<ul style="list-style-type: none"> • Check application if necessary • Check limit value • Adjust the limit value if required
BATCH OVERRUN ALARM	Batch size exceeded by more than set limit.	<ul style="list-style-type: none"> • Check valves in system for proper operation and/or leaks • Check limit value • Adjust the limit value if required
MODEM NOT PRESENT	The setup expects modem usage and a modem is not responding.	<ul style="list-style-type: none"> • Check setup for proper baud rate, parity, etc. • Check modem connection and cycle power to 926-ST1LE • Replace modem
SOFTWARE ERROR RESET	Software error	<ul style="list-style-type: none"> • Report error to factory
EXTENDED PFI LOCKUP	Unit was operated with an input power level lower than safe operating range for an extended period of time.	<ul style="list-style-type: none"> • Check data in unit. Totalizer may have inaccuracies • Investigate brownout cause.

13.3.2 Self Test Alarms

Error/Warning Message	Cause	Remedy
BATTERY LOW WARNING	Battery voltage too low	<ul style="list-style-type: none"> • Replace Battery • Consult Factory for service information
TIME CLOCK ERROR	The correct time/date is no longer shown	<ul style="list-style-type: none"> • Re-enter time and date. • If error occurs again contact factory
CAL CHECKSUM ERROR	Calibration constants have been corrupted	<ul style="list-style-type: none"> • Report error to factory
SETUP CHECKSUM ERROR	The units setup has been corrupted	<ul style="list-style-type: none"> • Report error to factory

Ordering Information

Example 926-ST1LE L 1 A 0 P ET

Series: _____

Display Type: _____
 L= LCD
 V= VFD

Input Type: _____
 1= 110 VAC
 2= 220 VAC
 3= 12 VDC (10 to 14 VDC)
 4= 24 VDC (14 to 28 VDC)

Relays: _____
 A= 2 SPDT Relays
 B= 4 SPDT Relays

Network Card: _____
 0= None (STD)
 2= RS485/Modbus (optional 2nd COM port)

Mounting: _____

- P**= Panel Mount (see Fig. 1)
- N**= NEMA 4 Wall Mount(see NEMAtrolST4X)
- W**= NEMA 12/13 Wall Mount w/ Clear Cover (see Fig.2)
- E**= Explosion Proof (No Button Access) (see XHVD 7/4)
- X**= Explosion Proof (with Button Access) ... (see XTROL 7/4)

- Options:** _____
- TB = RS485 Terminal Block for Panel Mount Enclosure
 - ET = Extended Temperature (consult factory)
 -4°F to 131°F (-20°C to 55°C)
 - IM = Internal Modem
 - M = Modem Power Option

Accessories:

- KEPS-KEP1-32
 KEP RS232 for 926-ST1LE • 32 Bit OPC/DDE Server
- KEPS-MBS32
 Supports RS485 for 926-ST1LE (Modbus RTU)
- Modem Available, see MPP-2400 and MPP-2400N (requires M option)
- Serial printer available, see P1000, P295
- Ethernet Port Server available, see IEPS
- RS-422/485 to RS-232 Communication Adaptor available, see CA285
- Remote metering and data collection software available, see TROLlink

WARRANTY

This product (excluding batteries) is warranted against defects in materials and workmanship for a period of two (2) years from the date of shipment to Buyer.

The Warranty is limited to repair or replacement of the defective unit at the option of the manufacturer. This warranty is void if the product has been altered, misused, dismantled, or otherwise abused.

ALL OTHER WARRANTIES, EXPRESSED OR IMPLIED, ARE EXCLUDED, INCLUDING BUT NOT LIMITED TO THE IMPLIED WARRANTIES OF MERCHANTABILITY AND FITNESS FOR A PARTICULAR PURPOSE.

Appendix A - Setup Menus

START HERE

SELECT EZ SETUP

INSTRUMENT TYPE

INSTRUMENT TYPE	SELECT PRESET TYPE	BATCH COUNT MODE	MAX. BATCH PRESET	BATCH OVERRUN COMP.	AUTO BATCH RESTART	TIME DELAY	FLOW SIGNAL TIMEOUT	MAX. DRAIN TIME	SLOW START QUANTITY
-----------------	--------------------	------------------	-------------------	---------------------	--------------------	------------	---------------------	-----------------	---------------------

SETUP INDICATORS

SETUP INDICATORS	TOTAL DESCRIPTOR	VOLUME UNITS	TOTAL DECIMAL PLACES	RATE TIME BASE	RATE DESCRIPTOR	RATE DECIMAL PLACES	RATE AVERAGE FILTER	QUICK UPDATE %
------------------	------------------	--------------	----------------------	----------------	-----------------	---------------------	---------------------	----------------

SETUP FLOW INPUT

EXCITATION VOLTAGE	PULSE INPUT TYPE	PULSE TRIGGER TYPE	LOW PASS FILTER	INPUT TERMINATION	MAX WINDOW	K-FACTOR TYPE	AVERAGE K _A -FACTOR	AVERAGE K _B -FACTOR	CHANGE TABLE A	CHANGE TABLE B	LOW FLOW RATE ALARM	HIGH FLOW RATE ALARM
--------------------	------------------	--------------------	-----------------	-------------------	------------	---------------	--------------------------------	--------------------------------	----------------	----------------	---------------------	----------------------

SETUP PULSE OUTPUT

PULSE OUTPUT USAGE	PULSE WIDTH	PULSE VALUE
--------------------	-------------	-------------

SETUP ANALOG OUTPUT

ANALOG OUTPUT USAGE	ANALOG OUTPUT RANGE	ANALOG OUTPUT LOW SCALE	ANALOG OUTPUT FULL SCALE	ANALOG OUTPUT DAMPING
---------------------	---------------------	-------------------------	--------------------------	-----------------------

SETUP RELAYS

SETUP RELAYS 1, 2, 3, 4	RELAY USAGE	RELAY DELAY	RELAY DURATION	RELAY MODE	RELAY SETPOINT	RELAY HYSTERESIS
-------------------------	-------------	-------------	----------------	------------	----------------	------------------

SETUP CONTROL INPUTS

SETUP CONTROL INPUTS 1, 2, 3	CONTROL INPUT 1 USAGE	CONTROL INPUT 2 USAGE	CONTROL INPUT 3 USAGE
------------------------------	-----------------------	-----------------------	-----------------------

SETUP REAL TIME CLOCK

SETUP REAL TIME CLOCK	CLOCK TYPE	SELECT CLOCK AMP/PI	TIME OF DAY	ENTER DATE
-----------------------	------------	---------------------	-------------	------------

SERIAL USAGE

SERIAL HARDWARE	DEVICE ID	BAUD RATE	PARITY	HANDSHAKE	DEVICE LINE FEED	MODEM CONTROL	MODEM AUTO ANSWER	CALL OUT NO	CALL OUT TIME	CALL ON ERROR/ALARM	NUMBER OF REDIALS	HANG-UP IF 2MIN. INACTIVE
-----------------	-----------	-----------	--------	-----------	------------------	---------------	-------------------	-------------	---------------	---------------------	-------------------	---------------------------

SETUP DATALOG/PRINT

SETUP DATALOG/PRINT	OUTPUT FORMAT	PAGE LENGTH	TOP MARGIN	DATALOG ONLY	PRINT TIME	PRINT INTERVAL	ENABLE PRINT KEY	PRINT END OF BATCH	CLEAR TOTAL IF PRINT	SELECT PRINT LIST ITEMS
---------------------	---------------	-------------	------------	--------------	------------	----------------	------------------	--------------------	----------------------	-------------------------

ADMINISTRATIVE SETUP

OPERATOR PASSWORD	SUPERVISOR PASSWORD	SOFTWARE VERSION	PRODUCT ORDER CODE	UNIT SERIAL NUMBER	SENSOR SERIAL NUMBER
-------------------	---------------------	------------------	--------------------	--------------------	----------------------

SETUP NETWORK CARD

SELECT NETWORK PROTOCOL	NETWORK DEVICE ID	BAUD RATE	PARITY
-------------------------	-------------------	-----------	--------

These functions will only appear with appropriate settings in other functions.